

STEVAL-ILL019V1 offline RRGB LED driver demonstration board with high PF

Introduction

The STEVAL-ILL019V1 demonstration board was developed to drive high brightness and power RRGB LEDs used in many different lighting applications. Thanks to RRGB LEDs, it is possible to easily modify the color of the light, change the brightness level, implement additional lighting features such as automatic color changes or a blinking mode, improve lighting efficiency compared to standard lighting products and finally also achieve significant energy savings. Typically, RRGB LED applications can be found as decorative lighting in houses or hotels, as architectural lighting in stadiums, historic buildings, bridges and monuments, as wall washing, shop lighting and in many other special lighting applications.

The STEVAL-ILL019V1 implements an innovative solution for driving multiple color RRGB LEDs, where high Power Factor, safety isolation and individual regulation of LED brightness are required. A constant current is set to 350 mA. Thanks to the microcontroller onboard, the output channels are independently controlled by four PWM signals, allowing the application users to set any color of the light or create automatic color effects. The demonstration board is shown in [Figure 1](#) and its ordering code is STEVAL-ILL019V1.

STEVAL-ILL019V1 main features

- Constant LED current: 350 mA
- 4 channels for RRGB LEDs designed on the board
- Line input voltage range: 88 V to 265 V AC
- Load: 5 to 13 LEDs per each channel
- 32 W maximum RRGB LED power (wide input voltage range)
- 42 W maximum RRGB LED power (EU input voltage range)
- Isolated SMPS
- Individual regulation of RRGB brightness
- EN55015 and EN61000-3-2 compliant
- Double-sided PCB, 145 mm x 75 mm x 27 mm

Figure 1. STEVAL-ILL019V1 demonstration board

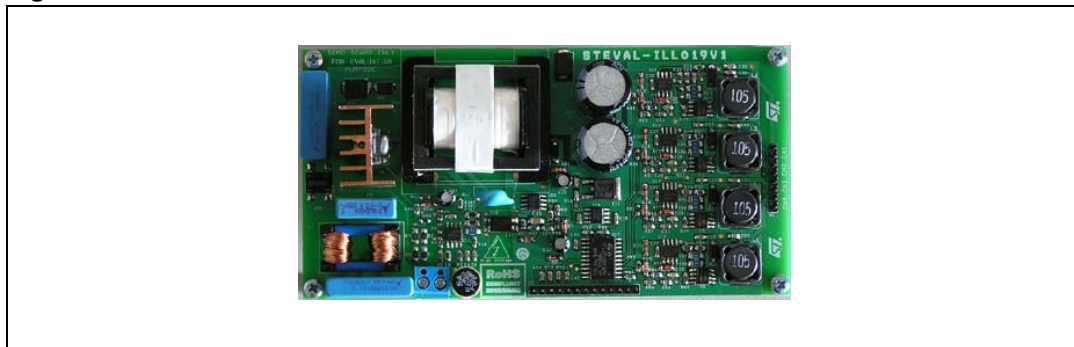

Contents

- 1 Getting started with the STEVAL-ILL019V1 5**
 - 1.1 Automatic color change mode 5
 - 1.2 Manual color change mode 6

- 2 Design concept 7**

- 3 STEVAL-ILL019V1 measurements 8**
 - 3.1 PF, THD efficiency 8
 - 3.2 Output current for different number of LEDs 10
 - 3.3 Maximum load capability 11
 - 3.4 Dimming 13
 - 3.5 Input and output electrical waveforms 13
 - 3.6 Thermal measurement 14
 - 3.7 Standard EN61000-3-2 measurement 15
 - 3.8 EMI measurement (EN55015) 16

- 4 Power transformer specifications 17**

- 5 Schematic diagrams 19**

- 6 Bill of material 21**

- 7 References 24**

- 8 Revision history 24**

List of tables

Table 1.	LED current vs. number of LEDs	11
Table 2.	Transformer design specifications	18
Table 3.	Bill of material - STEVAL-ILL019V1	21
Table 4.	Document revision history	24

List of figures

Figure 1.	STEVAL-ILL019V1 demonstration board	1
Figure 2.	Default RRGB LED load used for testing	5
Figure 3.	J3 connector with manual control circuitry	6
Figure 4.	Different color settings using manual color control	6
Figure 5.	STEVAL-ILL019V1 block diagram	7
Figure 6.	STEVAL-ILL019V1 demonstration board used for measurements	8
Figure 7.	Power Factor measurement	9
Figure 8.	Power Factor - zoom measurement	9
Figure 9.	Total Harmonic Distortion (THD) measurement	10
Figure 10.	Efficiency measurement	10
Figure 11.	Modified buck converter output current	11
Figure 12.	High PF flyback converter power capability for $V_{IN} = 88 \text{ V AC}$	12
Figure 13.	High PF flyback converter power capability for $V_{IN} = 185 \text{ V AC}$	12
Figure 14.	PWM dimming 50%	13
Figure 15.	PWM dimming 10%	13
Figure 16.	PWM dimming 1%	13
Figure 17.	PWM dimming 1% - zoom	13
Figure 18.	LED current measurement	14
Figure 19.	Input voltage and current waveforms for $V_{IN} = 110 \text{ V AC}$	14
Figure 20.	Input voltage and current waveforms for $V_{IN} = 230 \text{ V AC}$	14
Figure 21.	Thermal measurement on the STEVAL-ILL019V1	15
Figure 22.	EN61000-3-2 compliance for input voltage 110 V AC	16
Figure 23.	EN61000-3-2 compliance for input voltage 230 V AC	16
Figure 24.	Quasi-peak measurement from 9 KHz to 30 MHz	16
Figure 25.	Average measurement from 150 KHz to 30 MHz	16
Figure 26.	Transformer frame dimensions	17
Figure 27.	Transformer winding description	18
Figure 28.	Winding position on the transformer	18
Figure 29.	High PF flyback converter	19
Figure 30.	Four modified buck converters and microcontroller	20

1 Getting started with the STEVAL-ILL019V1

This section allows designers to quickly evaluate the board as the load and external potentiometer connections (to manually control the color of the light) are described.

As already stated, the light color can be changed automatically or manually. The application is set by default to automatic mode in case no potentiometer nor jumper is connected to the board via the J3 connector (see [Figure 1](#)). In order to control each LED channel manually, the potentiometers and jumper must be connected to the J3 connector. These two modes are demonstrated in the following sections.

1.1 Automatic color change mode

First, the RRGB LEDs must be connected to the board via the output connector J6 (see [Figure 1](#)). Four independent channels marked as CH1, CH2, CH3 and CH4 allow controlling four independent LED strings. The LED anode must be connected to the plus (+) pin and the LED cathode must be connected to the minus (-) pin, which is marked close to the connector J6. The recommended minimum LED voltage for each channel is 15 V and the maximum voltage is 40 V, in order to keep the LED current within $\pm 5\%$. As the typical LED forward voltage is 3.5 V, an LED string with 5 to 11 LEDs per channel must be used. The designers must also take into account that the maximum output LED power is 32 W for wide input voltage range (88 V to 265 V AC) and 42 W for EU input voltage range (188 V to 265 V AC). It is also possible to use only one, two or three channels. A typical example of how the load with RRGB LEDs can be designed is shown in [Figure 2](#) which is also the default RRGB LED load used for measurements on the STEVAL-ILL019V1 demonstration board. **In this case channel 1 has 6 green LEDs, channel 2 has 8 red LEDs, channel 3 has 7 green LEDs and channel 4 has 9 blue LEDs. This RRGB LED load is just for demonstration purposes and is not available for ordering.**

Figure 2. Default RRGB LED load used for testing

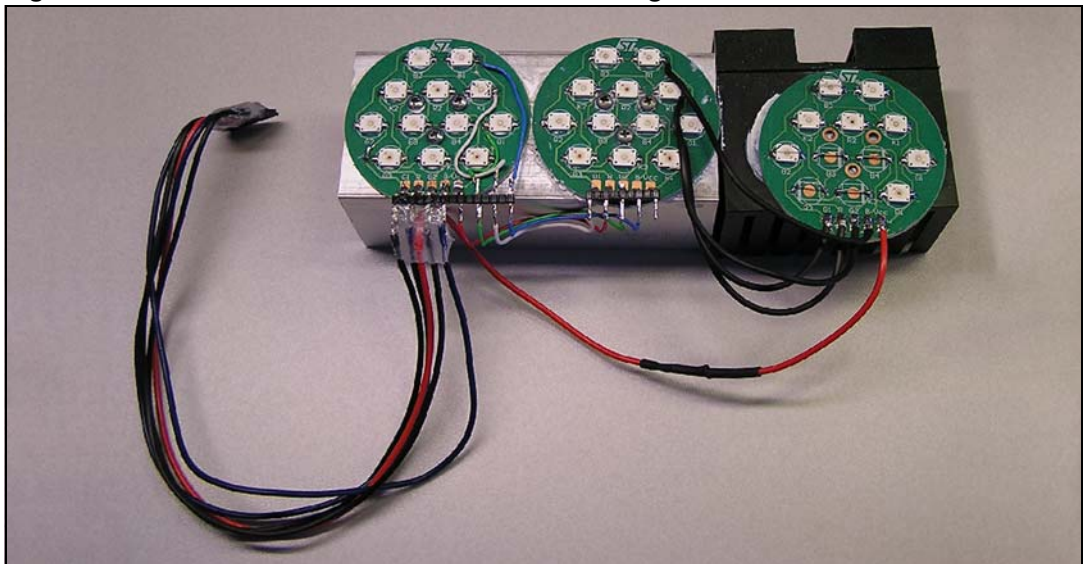

The last step after the RRGB LED load connection is to supply the demonstration board with the proper input voltage. The output light color is automatically changed as soon as the input voltage is applied to the board via connector J1.

1.2 Manual color change mode

First connect the RRGB LED load to the STEVAL-ILL019V1 as described in the previous section. Then connect the potentiometers to the J3 connector as demonstrated in [Figure 3](#). The control connector has three main purposes. Firstly, it is used in manufacturing to connect the programming station and program the ST7 microcontroller. Secondly, it connects up to four potentiometers to set the brightness of each LED string. For the RRGB LED module, only three potentiometers are used because two green LED strings are driven with the same brightness. The last feature on the connector is a “Mode selection Pin 9” which is used to choose either automatic or manual mode. During automatic mode, pin 9 is internally grounded. A positive voltage of 5 V must be connected to pin 9 (for example to use the switch S) for the manual mode. The automatic mode does not require any action from the user and changes the colors through the color spectrum. The manual mode keeps the color stable based on the position of the potentiometers. The last step is to resupply the board with the proper input voltage. The output light color can be manually tuned as demonstrated in [Figure 4](#). **The external control circuitry is again used just for demonstration purposes and is not available for ordering.**

Figure 3. J3 connector with manual control circuitry

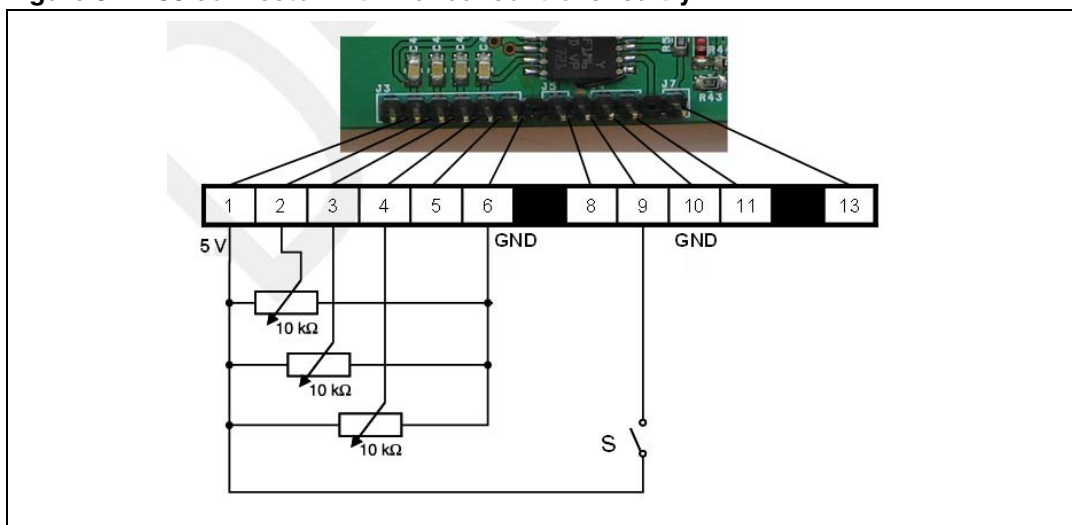
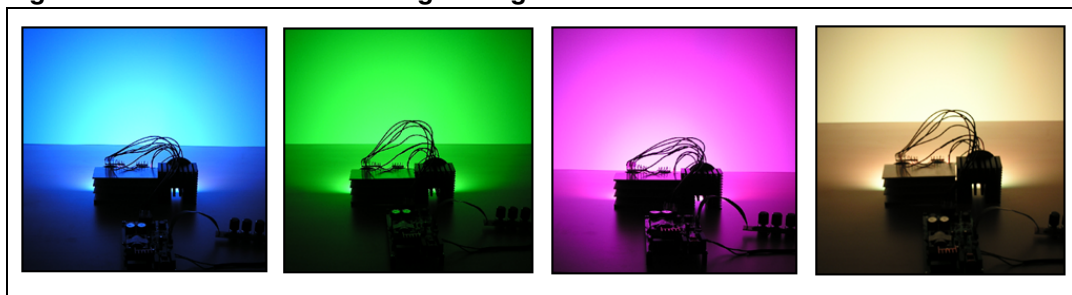

Figure 4. Different color settings using manual color control



2 Design concept

Figure 5 shows the STEVAL-ILL019V1 block diagram. Basically, the board consists of two converters. The first one is in fact an AC/DC converter designed as an isolated high PF flyback converter using the L6562A controller with the STP7NK80ZFP Power MOSFET as a switch. The input voltage for this converter can be between 88 V and 265 V AC and the converter delivers up to 35 W for this wide input voltage range. The output voltage is set to 48 V. The high Power Factor flyback converter was already designed separately for demonstration purposes (ordering code is EVL6562A-35WFLB) and therefore all design equations and calculations are described in AN2838 (see Section 7: References).

The second converter is in fact a constant current LED driver. It is a modified buck converter designed as the constant current source recommended for proper LED driving using the L6562A and STS4NF100 Power MOSFETs. Four independent DC/DC converters are assembled on the board in order to drive independent RRGB LED strings. The demonstration board for a modified buck converter was also developed (ordering code is EVL6562A-LED) and this design concept is described in AN2983 (see Section 7: References). All design equations for the modified buck converter are shown in AN2928 (see Section 7: References).

The color control and brightness regulation is provided by the PWM generator which has four independent channels. Each PWM signal is connected to one modified buck converter in order to set the required brightness level for each LED string. The PWM signal can be set between 0% and 100% (no brightness or maximum brightness). The ST7FLIT15BF1M6 microcontroller assembled on the board provides the right PWM signals. Thanks to the microcontroller, it is also possible to modify the light effects. The RRGB LED brightness can be set manually, if the external potentiometers are connected to the board via the connector J3.

Figure 5. STEVAL-ILL019V1 block diagram

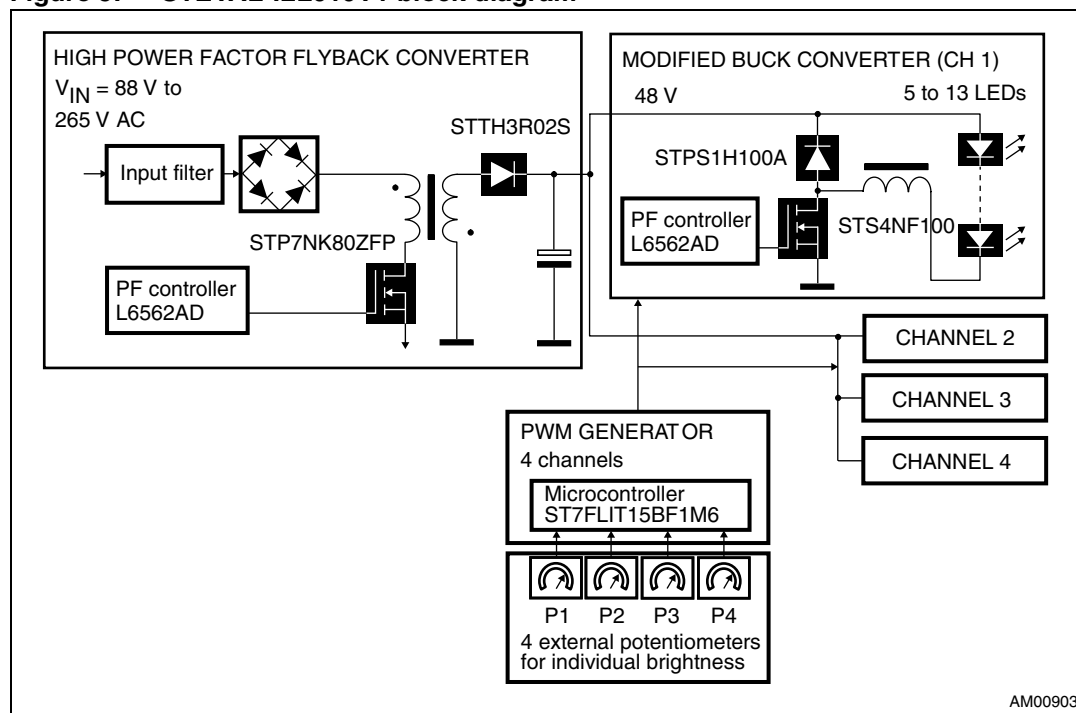

3 STEVAL-ILL019V1 measurements

The most important parameters such as electrical behavior, thermal behavior, dimming function, board power capability and standards (EN55015 and EN61000-3-2) were measured on the STEVAL-ILL019V1 demonstration board shown in [Figure 6](#) and the results are given in the following section.

Figure 6. STEVAL-ILL019V1 demonstration board used for measurements

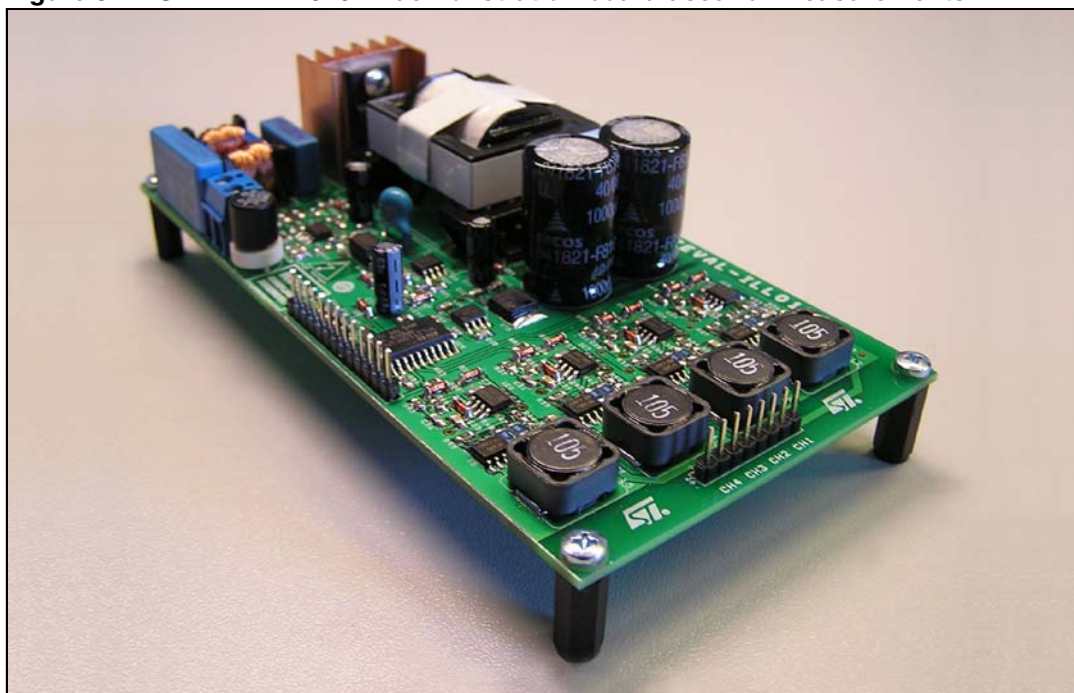

3.1 PF, THD efficiency

The power factor (PF) is shown in [Figure 7](#) and [Figure 8](#). Two RRGB LED loads are used for this measurement. Firstly, the default load of 30 W RRGB LEDs (9 blue LEDs, 13 green LEDs and 8 red LEDs) was used for the measurement and this load is shown in [Figure 2](#). The second load used for the measurement is 20 W RRGB LEDs (5 blue LEDs, 8 green LEDs and 7 red LEDs). The power factor is 0.995 for the input voltage 110 V AC and 0.94 for the input voltage 230 V AC (measured for 30 W load).

The total harmonic distortion (THD) measurement is demonstrated in [Figure 9](#). THD is 8.5 for the input voltage 110 V AC and 14.1 for the input voltage 230 V AC (measured for 30 W load).

The efficiency measurement for these two loads is shown in [Figure 10](#). The efficiency is approximately 75% for a 30 W load, which is in line with the estimation performance because there are two converters (AC/DC and DC/DC) used in the design.

Figure 7. Power Factor measurement

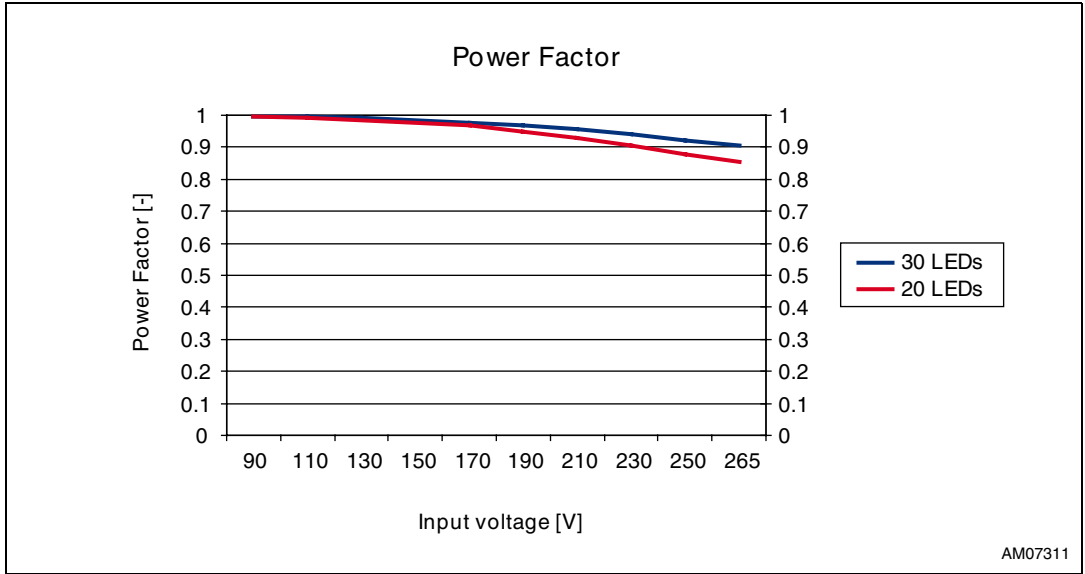

Figure 8. Power Factor - zoom measurement

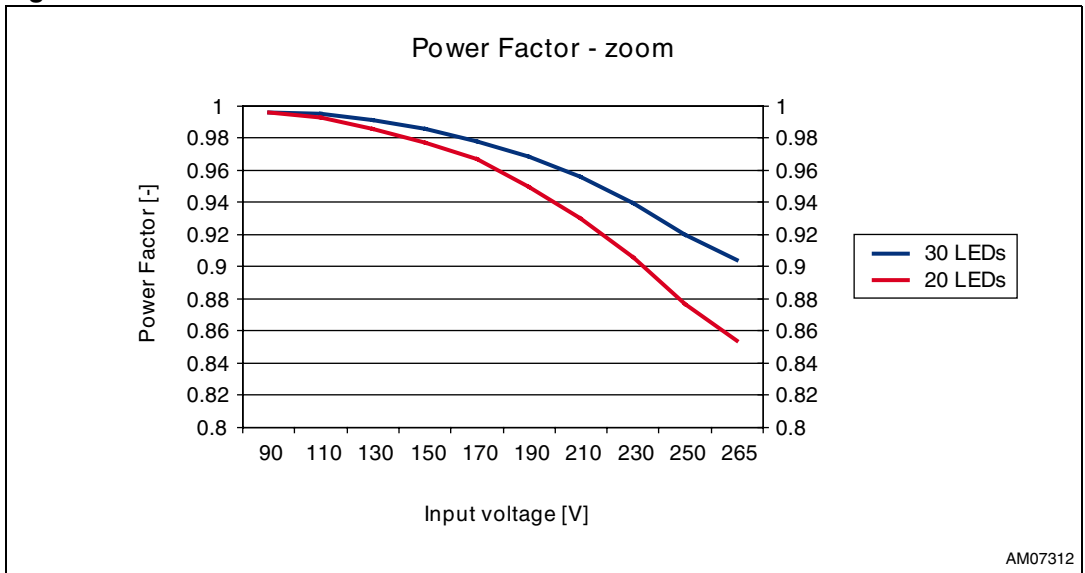

Figure 9. Total Harmonic Distortion (THD) measurement

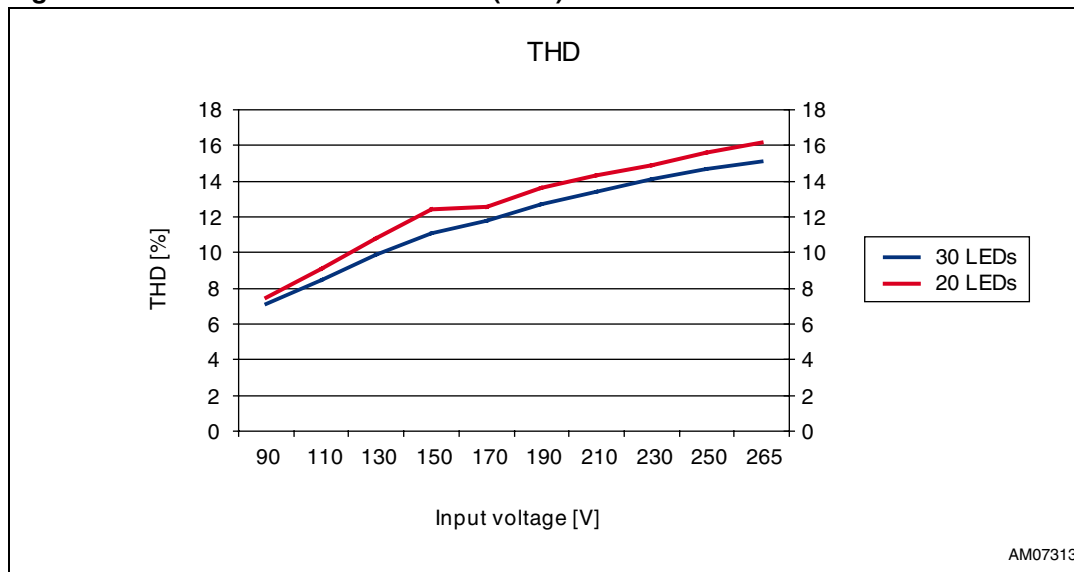
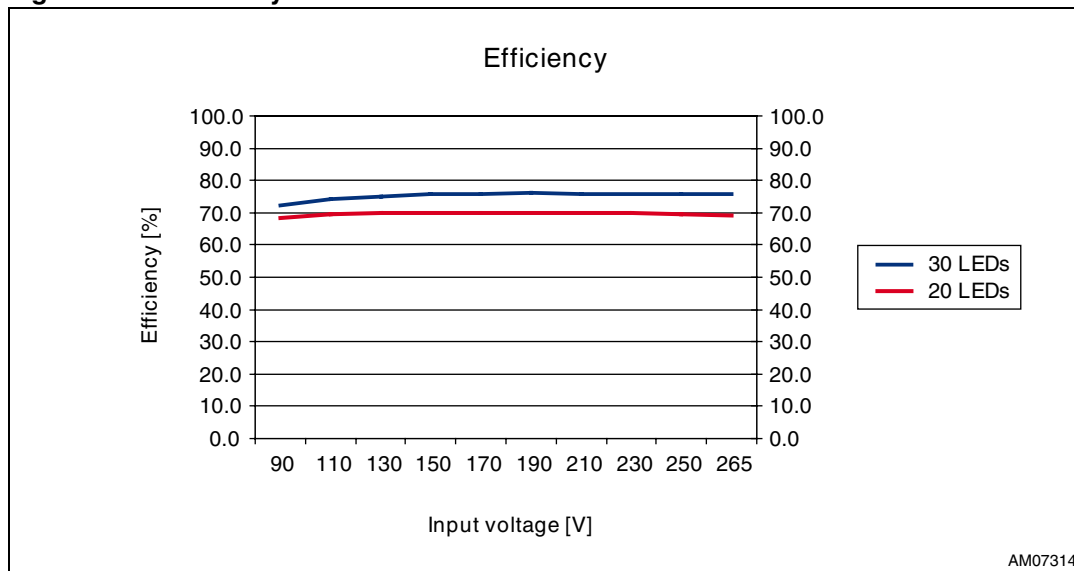

Figure 10. Efficiency measurement



3.2 Output current for different number of LEDs

Thanks to the modified buck converter designed as the current source (additional feedback resistors R56, R57, R58 and R59 in the design), it is possible to drive a variable number of LEDs. The output constant current was checked for different numbers of LEDs connected to the modified buck converter and the result is demonstrated in [Table 1](#) and [Figure 11](#). It is recommended to have the output voltage between 15 V and 38 V in order to keep the output LED current within approximately $\pm 5\%$. An established number of LEDs follows the output voltage recommendation and can be easily calculated as the LED forward voltage is a typical parameter written in any LED datasheet.

Table 1. LED current vs. number of LEDs

Number of LEDs	4	5	6	7	8	9	10	11	12	13
I_{LED} [mA]	390	362	351	346	346	348	350	351	355	357
V_{LED} [V]	12.1	15	17.9	20.8	23.7	26.7	29.7	32.7	35.6	38.7

Figure 11. Modified buck converter output current

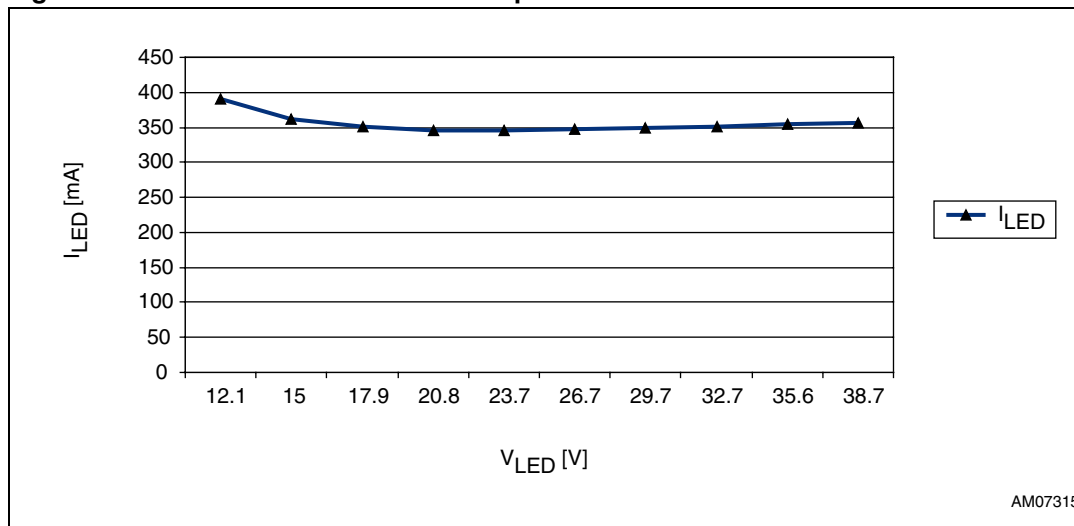

3.3 Maximum load capability

One of the most important features regarding this reference design is its maximum power capability because it limits the maximum number of LEDs connected to this board. The power capability measurement for wide input voltage range is shown in *Figure 12*. The worst case for the measurement is the minimum input voltage and therefore the board was tested with the input voltage 88 V AC. The maximum power is limited by the high PF flyback converter and so its power capability is measured separately (resistive load is connected to the output of the high PF flyback converter - capacitor C10). *Figure 12* shows that the output voltage starts to decrease as soon as the load current reaches 0.7 A (blue waveform). As indicated by the red waveform, the maximum output power is limited to 35 W. The inverted buck converters are used as the second stage DC/DC converter and it is possible to estimate their efficiency at 90% (also measured). Therefore maximum power capability of the STEVAL-ILL019V1 for wide input voltage range is 32 W. Also, the Power MOSFET and transformer temperature was checked after one hour with maximum load (35.8 W) with 88 V input voltage (ambient temperature 25 °C). The Power MOSFET had a temperature of 61 °C and the transformer had a temperature of 60 °C.

The maximum power capability for the EU voltage range (188 V to 265 V AC) is also measured, refer to *Figure 13*. The high PF flyback converter is again measured separately using a resistive load connected to the capacitor C10. In this case the maximum power limit is above 35 W, as the minimum input voltage was set to 188 V AC. Finally, a higher input voltage (188 V) compared to a wide input voltage range (88 V) means that the primary current is lower (avoiding transformer saturation) and therefore the high PF converter is able to deliver higher power to the load for the EU input voltage range. In this case, the maximum

power capability is limited by the temperature of the power components (mainly the transformer and Power MOSFET). The maximum Power MOSFET and inductor temperature was selected at 61 °C in order to have the same maximum temperature on the transformer and Power MOSFET as that of the wide input voltage range. The temperature was measured after 1 hour and the Power MOSFET had a temperature of 59 °C and the transformer had a temperature of 61 °C for load power of 46 W. Efficiency for the inverted buck converter can be again estimated at 90% and therefore maximum power capability of the STEVAL-ILL019V1 for the EU input voltage range is 42 W as shown in [Figure 13](#).

Figure 12. High PF flyback converter power capability for $V_{IN} = 88 \text{ V AC}$

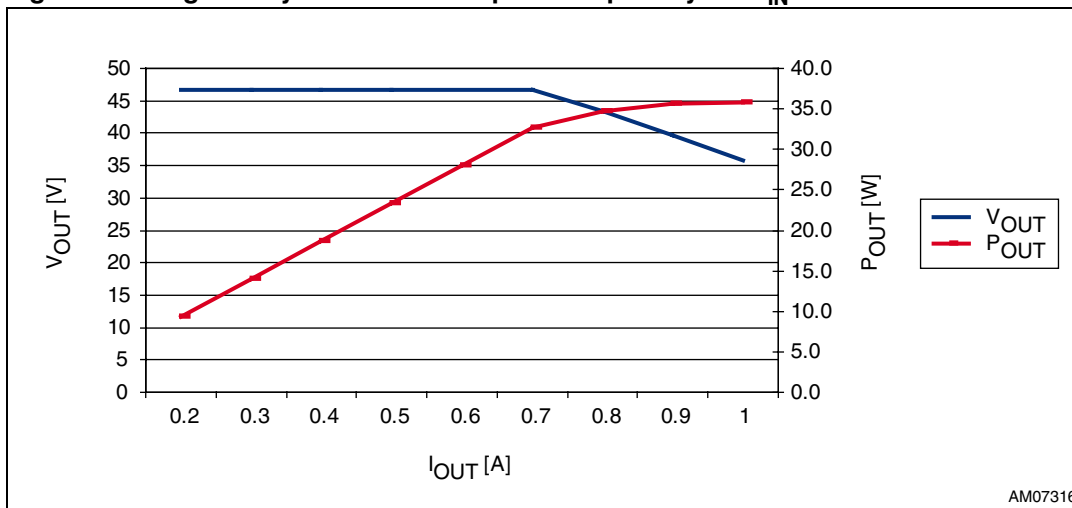
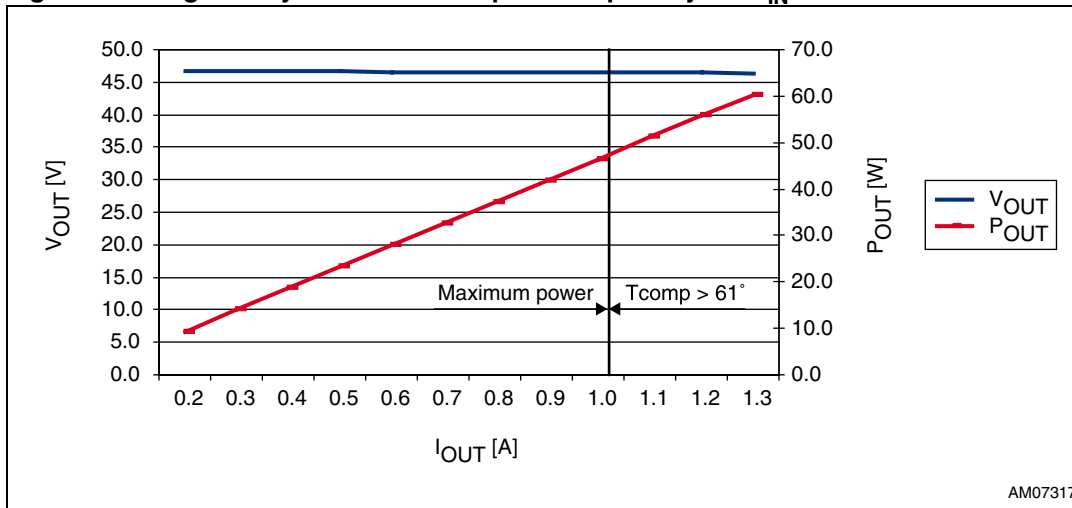

Figure 13. High PF flyback converter power capability for $V_{IN} = 185 \text{ V AC}$



3.4 Dimming

The dimming function on the STEVAL-ILL019V1 was evaluated. One output channel (channel 4 with 9 blue LEDs) of the inverted buck converter was measured. *Figure 14* to *Figure 17* show the output LED current and voltage for brightness levels set to 50%, 10% and 1%. Thanks to the inverted buck topology, the application can be also completely switched off (no current flows to the LEDs), because the Power MOSFET is turned off by the PWM signal (the L6562A controls the Power MOSFET).

Figure 14. PWM dimming 50%

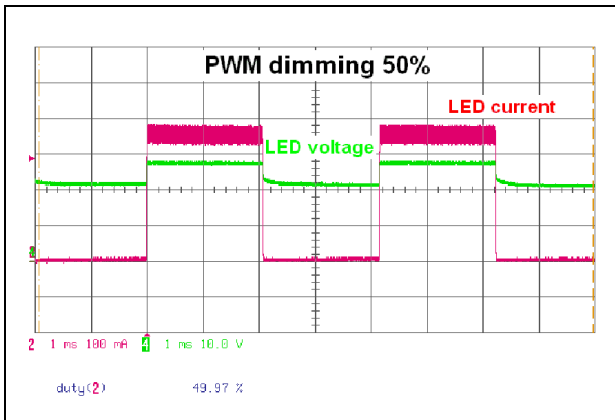

Figure 15. PWM dimming 10%

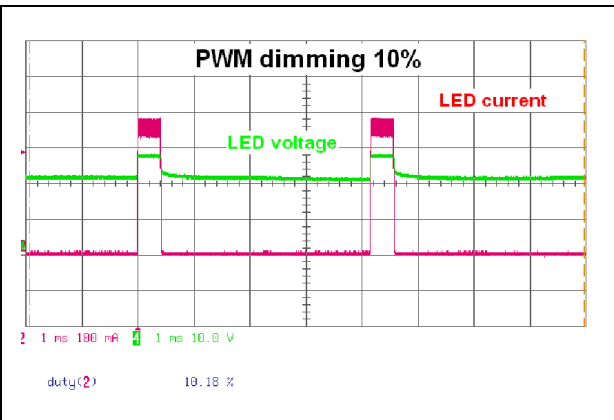

Figure 16. PWM dimming 1%

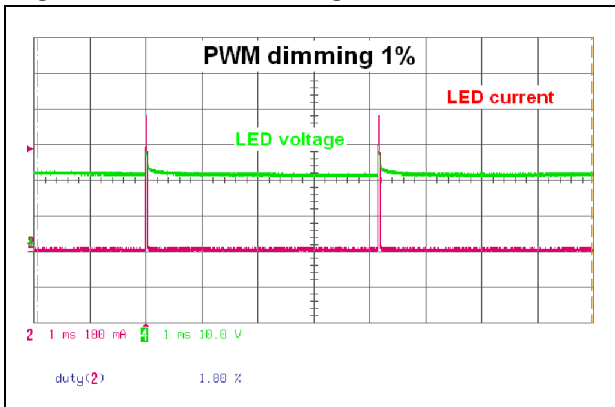
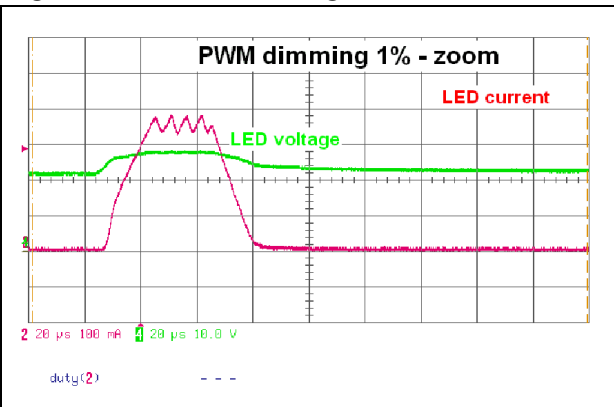

Figure 17. PWM dimming 1% - zoom



3.5 Input and output electrical waveforms

The LED current measured for one channel (channel 4 with 9 blue LEDs) is shown in *Figure 18*. The LED average current is 350 mA, the inverted buck converter switching frequency is 189 kHz and the peak-to-peak LED current ripple is 57.8 mA.

Figure 19 shows the input current and voltage waveforms for the input voltage 110 V AC. The default load of 30 W RRGB LEDs is used for this measurement. In this case the STEVAL-ILL019V1 has PF = 0.995 and THD = 8.5%.

Figure 20 shows the input current and voltage waveforms for the input voltage 230 V AC. The default load of 30 W RRGB LEDs is again used for this measurement. In this case the STEVAL-ILL019V1 has PF = 0.94 and THD = 14.1%.

Figure 18. LED current measurement

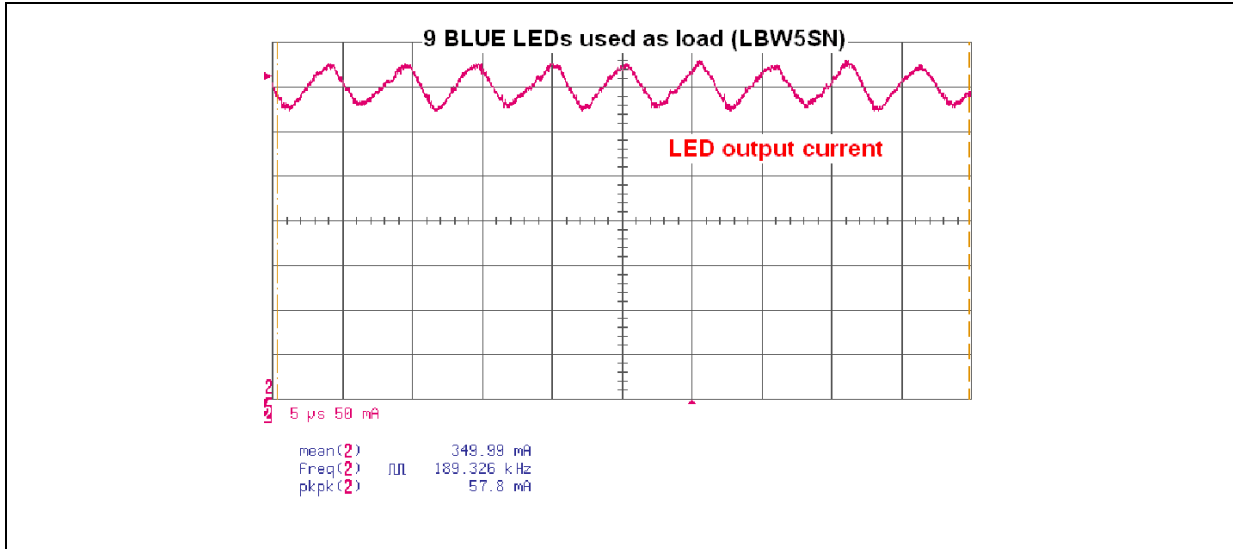

Figure 19. Input voltage and current waveforms for $V_{IN} = 110\text{ V AC}$

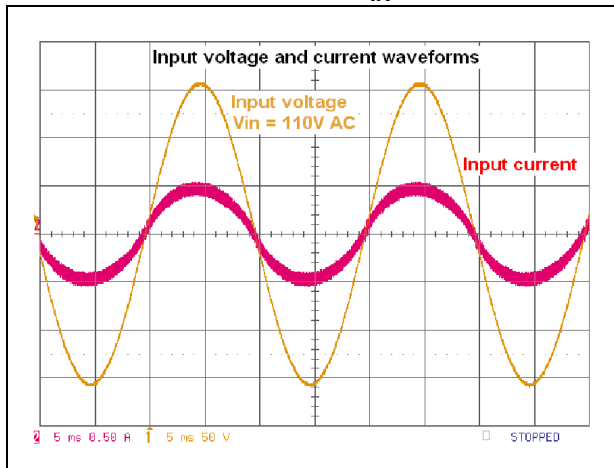
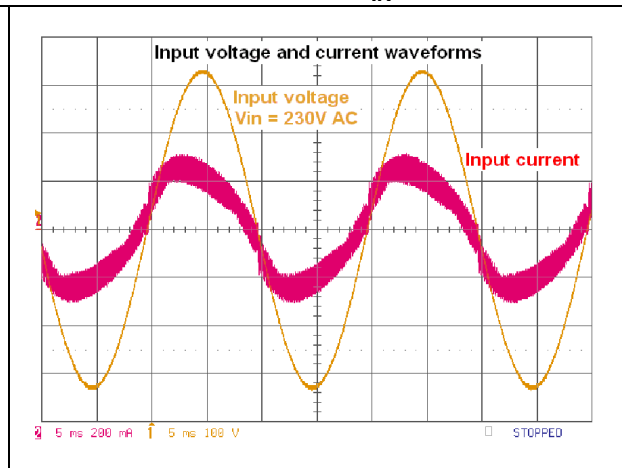

Figure 20. Input voltage and current waveforms for $V_{IN} = 230\text{ V AC}$



3.6 Thermal measurement

Thanks to the thermal chamber and camera, the overall temperature for all the components assembled on the STEVAL-ILL019V1 is easily detected. [Figure 21](#) shows the thermal behavior for ambient temperature 25 °C, input voltage 230 V AC and 30 W RRGB LED load. The maximum temperature is 76.1 °C and it is measured on the sense resistors R35, R36, R41 and R42, on the Power MOSFET T3 and T4 and also on the linear voltage regulator IC3.

Figure 21. Thermal measurement on the STEVAL-ILL019V1

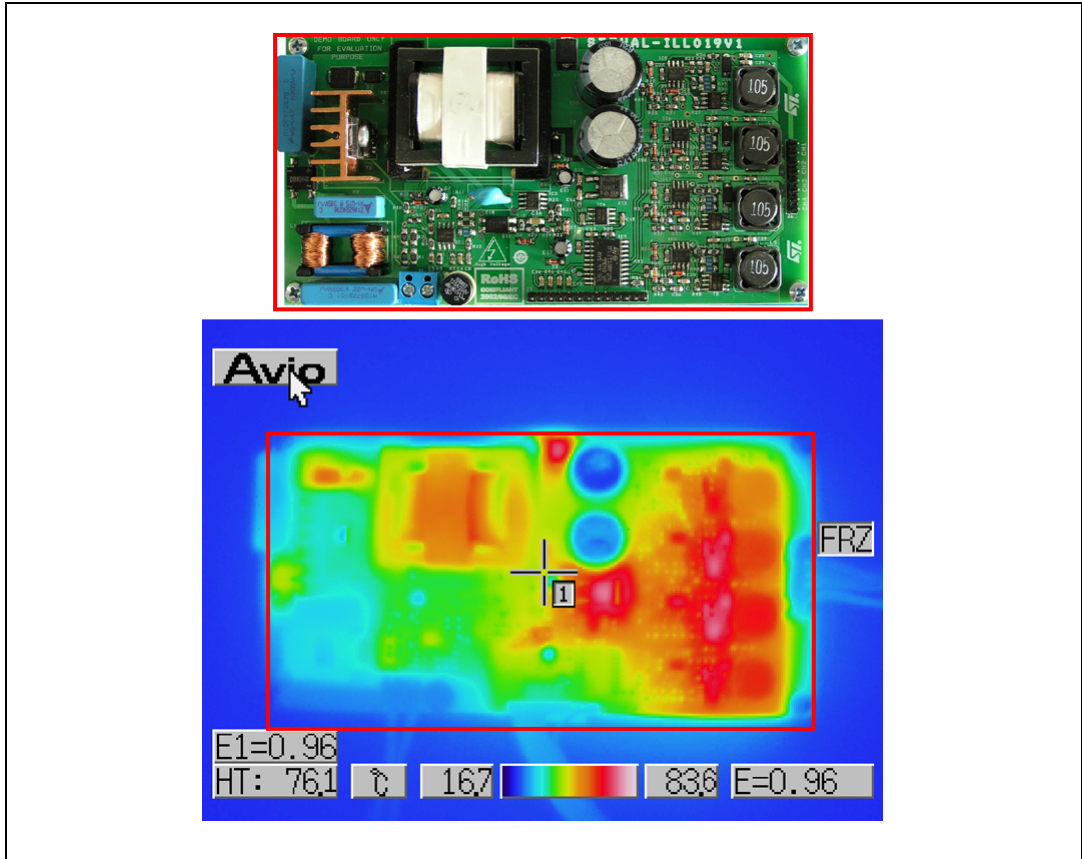

3.7 Standard EN61000-3-2 measurement

If the input power for a lighting application is above 25 W, then it is required to have an active Power Factor Correction (PFC) circuit in the final application. The high PF flyback converter with the L6562A controller (transition mode PFC controller) is perfectly suitable for such applications. Thanks to this design approach, input voltage 110 V AC or input voltage 230 V AC meets the standard EN61000-3-2 as seen in [Figure 22](#) and [Figure 23](#).

Figure 22. EN61000-3-2 compliance for input voltage 110 V AC

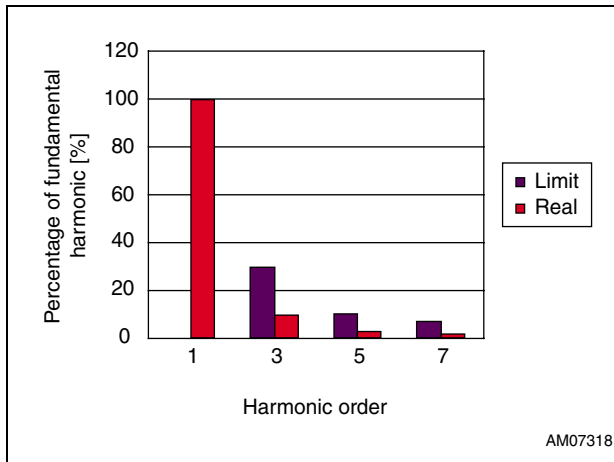
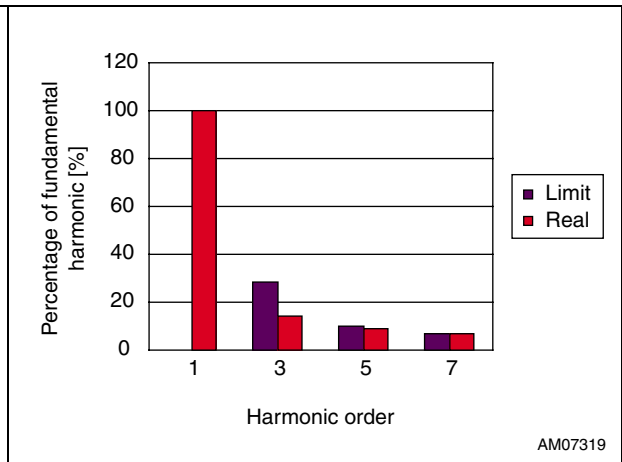

Figure 23. EN61000-3-2 compliance for input voltage 230 V AC



3.8 EMI measurement (EN55015)

The norm EN55015 (CISPR15) describes the limits and methods of measuring radio disturbance characteristics of electrical lighting and similar equipment. The limits of the mains terminal disturbance voltages for quasi-peak measurement for frequency range from 9 KHz to 30 MHz and the real measurement is demonstrated in [Figure 24](#). The test was performed with input voltage $V_{IN} = 230$ V AC, 30 W RGG B LED load and the LED brightness was set to maximum level. The limits of the mains terminal disturbance voltages for average measurement for frequency range from 150 KHz to 30 MHz and the real measurement is shown in [Figure 25](#). These results comply with the standard EN55015 as shown in [Figure 24](#) and [Figure 25](#).

Figure 24. Quasi-peak measurement from 9 KHz to 30 MHz

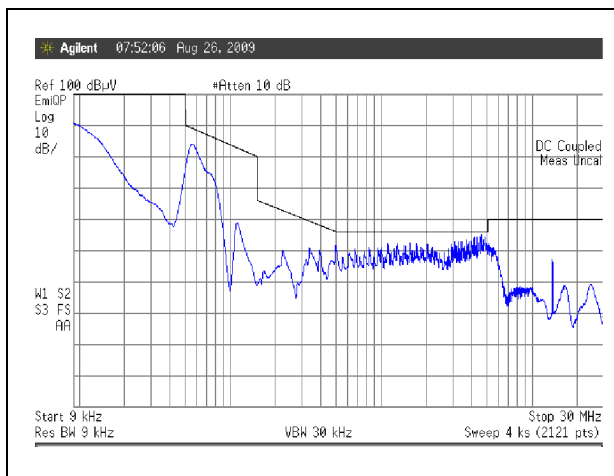
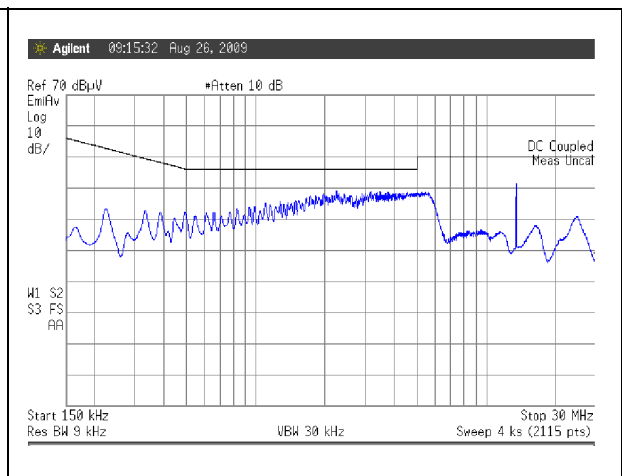

Figure 25. Average measurement from 150 KHz to 30 MHz



4 Power transformer specifications

Transformer type:

- Winding type: layer
- Core type: ER30
- Coil former: horizontal type, 9 + 9 pins (see dimensions in [Figure 26](#))
- Mains insulation: 4 KV

Figure 26. Transformer frame dimensions

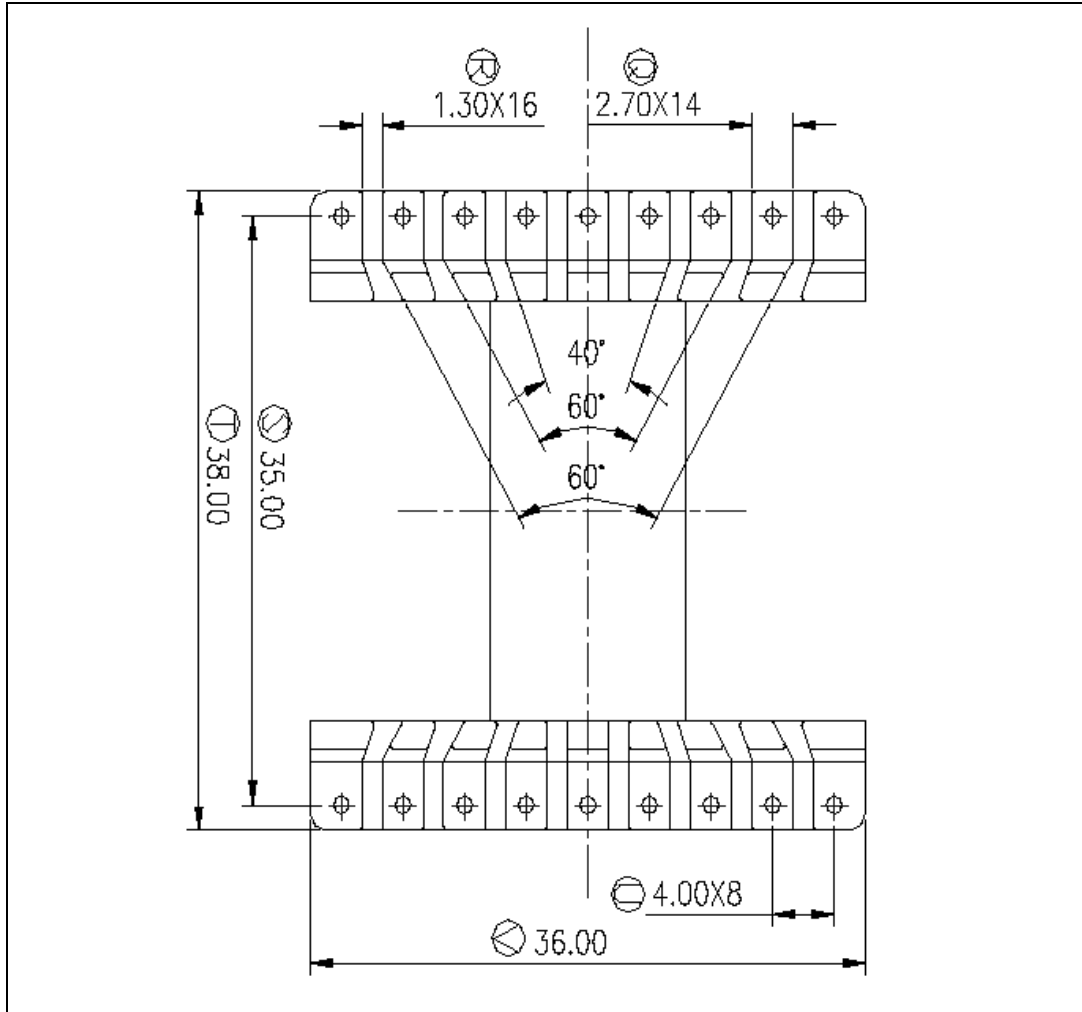

Electrical specifications for the transformer:

- Converter topology: flyback, TM mode
- Ferrite material PC40 or similar for SMPS
- Min. operating frequency: 36 kHz
- Inductance factor approximately $Al = 90$ nH; air gap in central leg
- Primary inductance 1.61 mH
- Primary winding $N1 + N2 = 134$ turns

Table 2. Transformer design specifications

Winding	Layer sequence	Start pin number	Finish pin number	Turns	Wire diameter (mm)	Side
N1	5	3	1	67	0.4	Primary
N2	2	5	3	67	0.4	Primary
N3	1	8	7	13	0.2	Primary
N4	3	17, (18)	14, (15)	33	2*0.4	Secondary
N5	4	11	12	17	0.2	Secondary
N6	9 - over core	8	8	1	Cu foil	Shielding

Note: Intersperse winding N3, N5 through as much of the winding area as possible in order to reduce the leakage inductance (since these windings do not completely fill a layer, the winding should be spaced evenly across the layers). Each layer of windings N1 and N2 must be isolated by a single layer of Mylar® Tape.

Figure 27. Transformer winding description

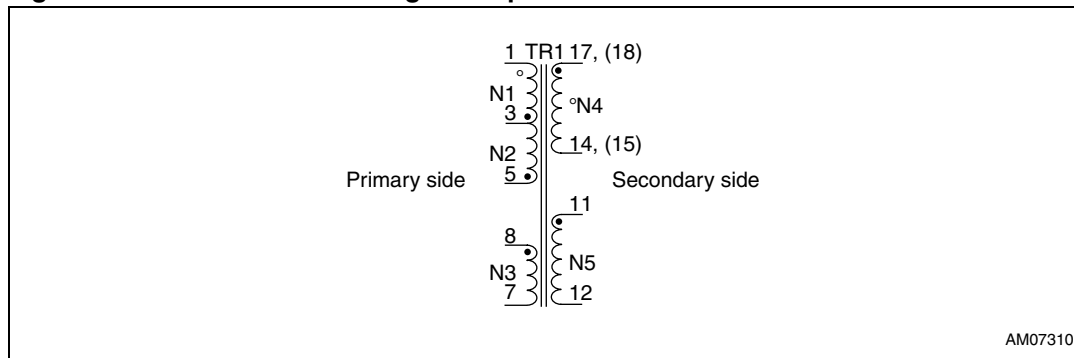
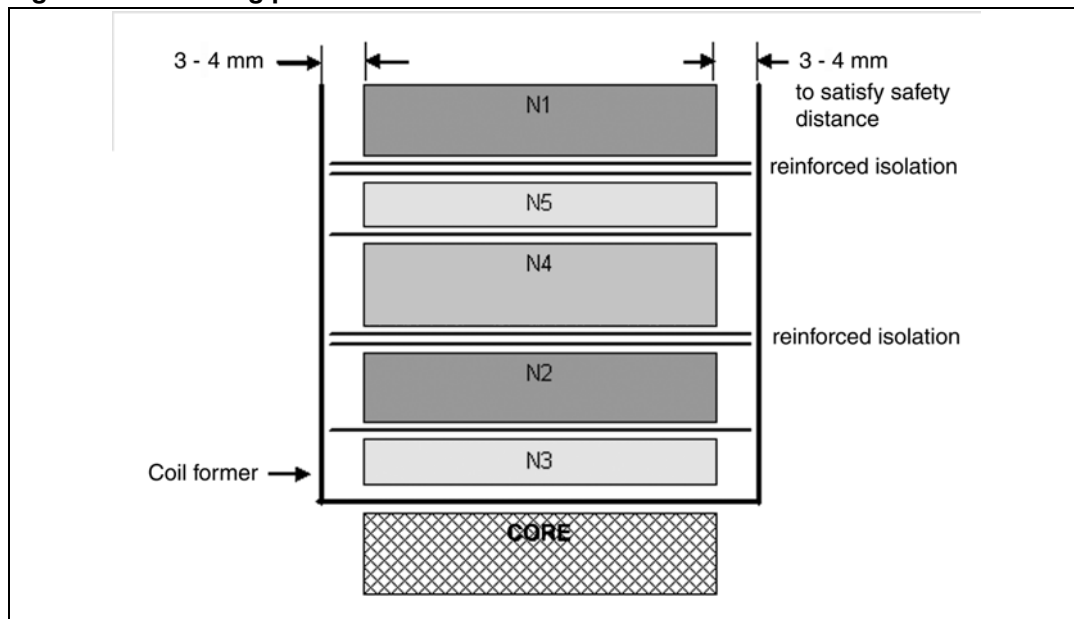
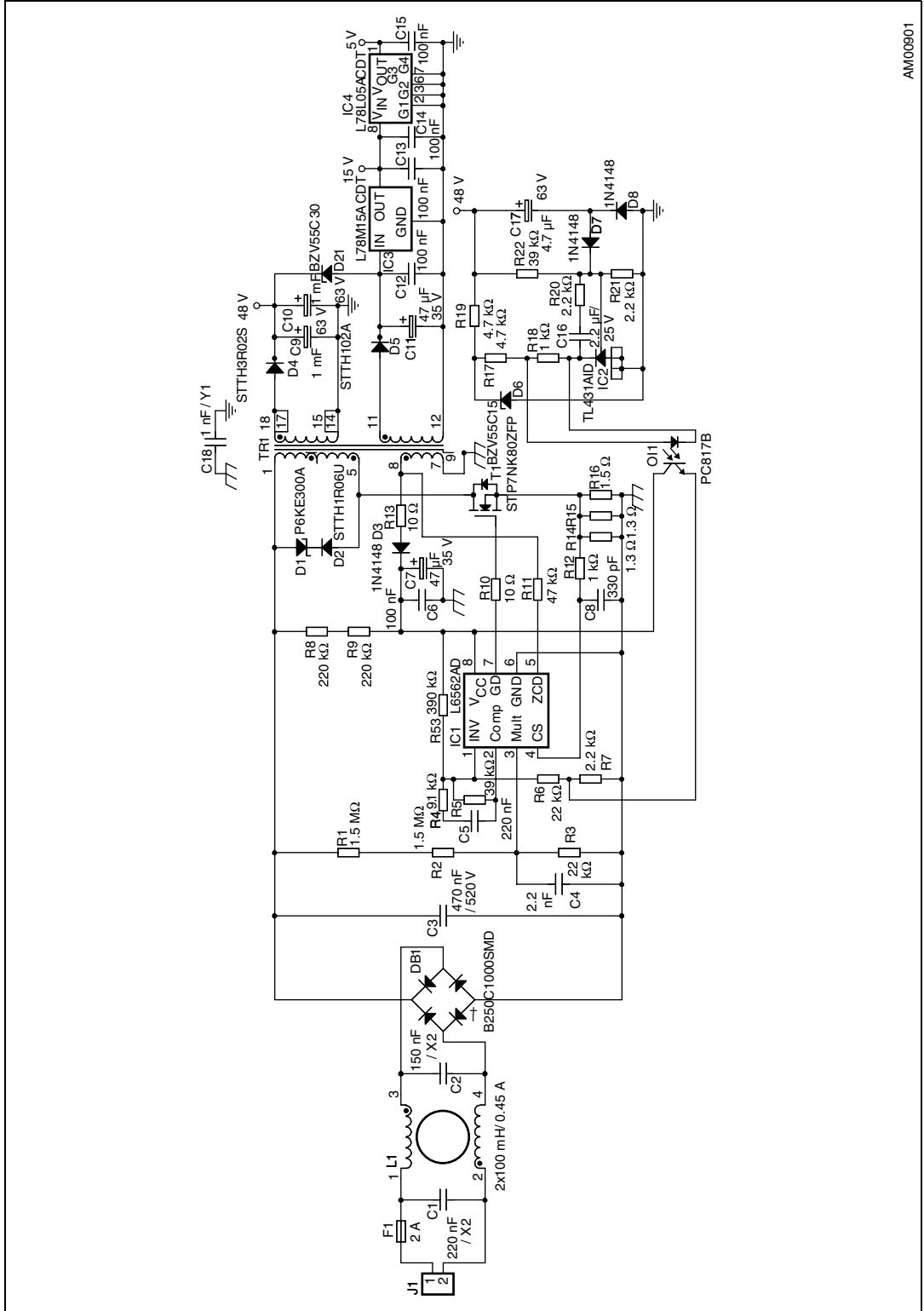

Figure 28. Winding position on the transformer



5 Schematic diagrams

Figure 29. High PF flyback converter



AM00901

Figure 30. Four modified buck converters and microcontroller

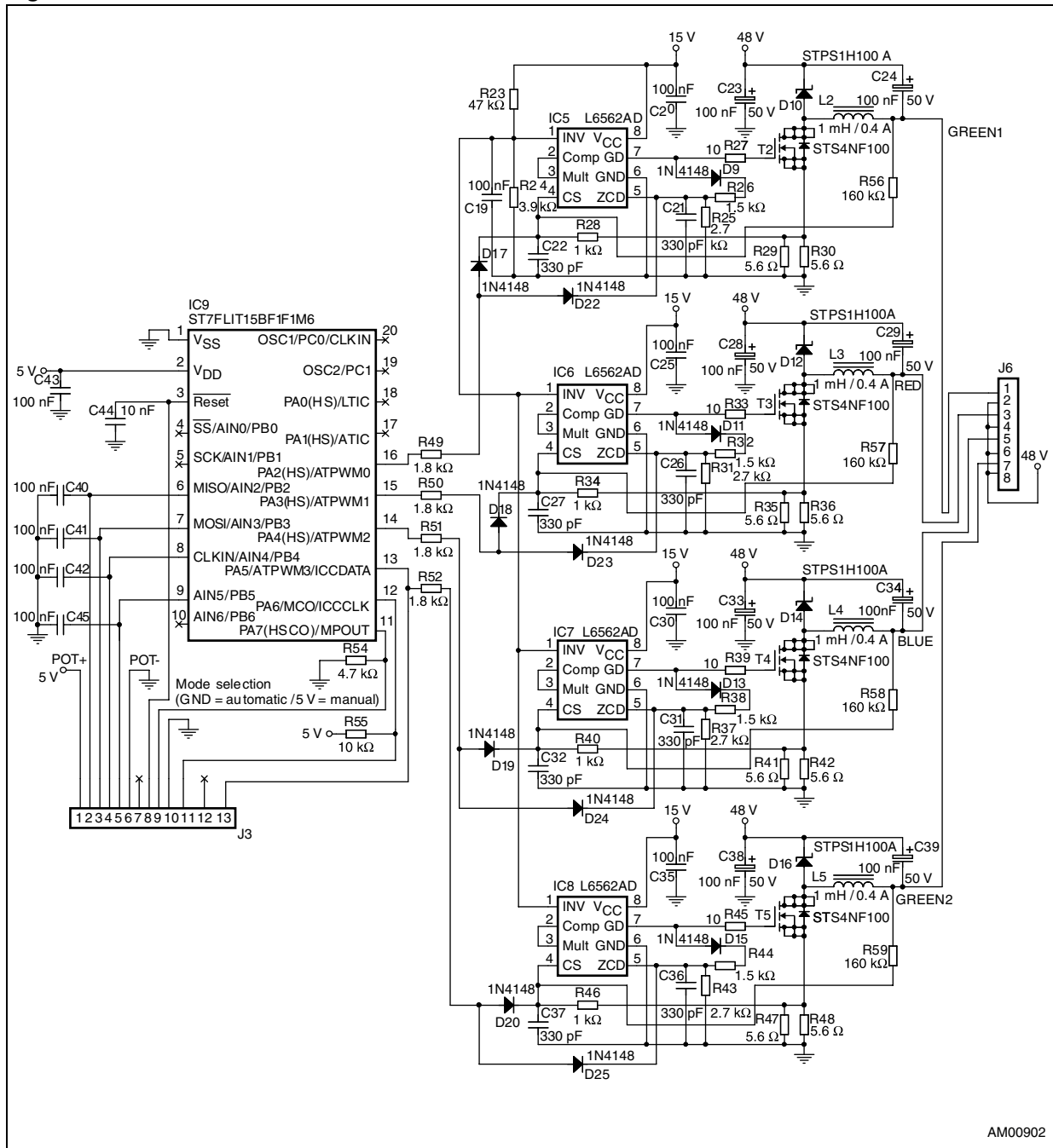

AM00902

6 Bill of material

Table 3. Bill of material - STEVAL-ILL019V1

I	Q	Reference	Part	Type	Manufacturer	Ordering code
1	1	C1	220 nF / ~305 V AC	X2 capacitor	EPCOS	B32923C3224M
2	1	C2	150 nF / ~305 V AC	X2 capacitor	EPCOS	B32922C3154M
3	1	C3	470 nF / ~305 V AC	X2 capacitor	EPCOS	B32923C3474M
4	1	C4	2.2 nF / 63 V	0805 SMD capacitor		
5	1	C5	220 nF / 63 V	0805 SMD capacitor		
6	23	C6, C12, C13, C14, C15, C19, C20, C23, C24, C25, C28, C29, C30, C33, C34, C35, C38, C39, C40, C41, C42, C43, C45	100 nF / 63 V	0805 SMD capacitor		
7	2	C7, C11	47 µF / 35 V	Electrolytic capacitor		
8	1	C8	330 pF / 63 V	0805 SMD capacitor		
9	2	C9, C10	1 mF / 63 V	Electrolytic capacitor	EPCOS	B41821F8108M
10	1	C16	2.2 µF / 25 V	1206 ceramic capacitor X7R	AVX	12063C225KAT2A
11	1	C17	4.7 µF / 63 V	Electrolytic capacitor		
12	1	C18	1 nF / 250 V AC	Y1 capacitor	Murata Manufacturing Co., Ltd.	DE1E3KX102MA5B
13	8	C21, C22, C26, C27, C31, C32, C36, C37	330 pF / 63 V	0805 SMD capacitor		
14	1	C44	10 nF / 63 V	0805 SMD capacitor		
15	1	DB1	1 A / 250 V	Diode bridge SMD		
16	1	D1	P6KE300A	Transil™ unidirectional 300 V	STMicroelectronics	P6KE300A
17	1	D2	STTH1R06U	1 A / 600 V ultrafast diode	STMicroelectronics	STTH1R06U
18	15	D3, D7, D8, D9, D11, D13, D15, D17, D18, D19, D20, D22, D23, D24, D25	1N4148	150 mA / 75 V universal diode		
19	1	D4	STTH3R02S	3 A / 200 V ultrafast diode	STMicroelectronics	STTH3R02S
20	1	D5	STTH102A	1 A / 200 V ultrafast diode	STMicroelectronics	STTH102A

Table 3. Bill of material - STEVAL-ILL019V1 (continued)

I	Q	Reference	Part	Type	Manufacturer	Ordering code
21	1	D6	BZV55C15	15 V Zener diode (SOD80)		
22	4	D10, D12, D14, D16	STPS1H100A	1 A / 100 V Schottky diode	STMicroelectronics	STPS1H100A
23	1	D21	BZV55C30	30 V Zener diode (SOD80)		
24	1	F1	2.5 A / 250 V	Fuse		
25	1	F1	Fuse socket			
26	5	H1, H2, H3, H4, T1HEAT	Screw	Screw 3 x 6 mm		
27	4	H11, H22, H33, H44	Column distance	15 mm		
28	5	IC1, IC5, IC6, IC7, IC8	L6562AD	PFC controller	STMicroelectronics	L6562AD
29	1	IC2	TL431AID	Programmable voltage reference	STMicroelectronics	TL431AID
30	1	IC3	L78M15ACDT	Linear voltage regulator	STMicroelectronics	L78M15ACDT
31	1	IC4	L78L05ACD13TR	Linear voltage regulator	STMicroelectronics	L78L05ACD13TR
32	1	IC9	ST7FLIT15BF1M6	Microcontroller	STMicroelectronics	ST7FLIT15BF1M6
33	1	J1	ARK120/2	Input connector		
34	2	J3, J6	S1G40	Control connector 40-pin		
35	1	L1	B82732F2451B001	Frame core chokes 2 x 100 mH / 0.45 A	EPCOS	B82732F2451B001
36	4	L2, L3, L4, L5	MSS1260-105KLD	1 mH / 0.4 A	Coilcraft	MSS1260-105KLD
37	1	OI1	PC817B	Optocoupler		
38	2	R1, R2	1.5 M Ω	1206 SMD resistor		
39	2	R3, R6	22 K Ω	0805 SMD resistor		
40	1	R4	9.1 K Ω	0805 SMD resistor		
41	2	R5, R22	39 K Ω	0805 SMD resistor		
42	3	R7, R20, R21	2.2 K Ω	0805 SMD resistor		
43	2	R8, R9	220 K Ω	1206 SMD resistor		
44	6	R10, R13, R27, R33, R39, R45	10 Ω	0805 SMD resistor		
45	2	R11, R23	47 K Ω	0805 SMD resistor		
46	6	R12, R18, R28, R34, R40, R46	1 K Ω	0805 SMD resistor		

Table 3. Bill of material - STEVAL-ILL019V1 (continued)

I	Q	Reference	Part	Type	Manufacturer	Ordering code
47	2	R14, R15	1.3 Ω	1206 SMD resistor		
48	1	R16	1.5 Ω	1206 SMD resistor		
49	3	R17, R19, R54	4.7 K Ω	0805 SMD resistor		
50	1	R24	3.9 K Ω	0805 SMD resistor		
51	4	R25, R31, R37, R43	2.7 K Ω	0805 SMD resistor		
52	4	R26, R32, R38, R44	1.5 K Ω	0805 SMD resistor		
53	8	R29, R30, R35, R36, R41, R42, R47, R48	5.6 Ω	1206 SMD resistor		
54	4	R49, R50, R51, R52	1.8 K Ω	0805 SMD resistor		
55	1	R53	390 K Ω	0805 SMD resistor		
56	1	R55	10 K Ω	0805 SMD resistor		
57	4	R56, R57, R58, R59	160 K Ω	0805 SMD resistor		
58	1	TR1	ER30 core	Specified in this document	TDK	
59	1	T1	STP7NK80ZFP	Power MOSFET 9 A / 800 V	STMicroelectronics	STP7NK80ZFP
60	1	T1HEAT	HEATSINK			
61	4	T2, T3, T4, T5	STS4NF100	Power MOSFET 4 A / 100 V	STMicroelectronics	STS4NF100

7 References

1. STMicroelectronics, Application note AN2838, 35 W wide-range high power factor flyback converter demonstration board using the L6562A; see www.st.com.
2. STMicroelectronics, Application note AN2983, Constant current inverse buck LED driver using L6562A, see www.st.com.
3. STMicroelectronics, Application note AN2928, Modified buck converter for LED applications, see www.st.com.

8 Revision history

Table 4. Document revision history

Date	Revision	Changes
25-Oct-2010	1	Initial release.

Please Read Carefully:

Information in this document is provided solely in connection with ST products. STMicroelectronics NV and its subsidiaries ("ST") reserve the right to make changes, corrections, modifications or improvements, to this document, and the products and services described herein at any time, without notice.

All ST products are sold pursuant to ST's terms and conditions of sale.

Purchasers are solely responsible for the choice, selection and use of the ST products and services described herein, and ST assumes no liability whatsoever relating to the choice, selection or use of the ST products and services described herein.

No license, express or implied, by estoppel or otherwise, to any intellectual property rights is granted under this document. If any part of this document refers to any third party products or services it shall not be deemed a license grant by ST for the use of such third party products or services, or any intellectual property contained therein or considered as a warranty covering the use in any manner whatsoever of such third party products or services or any intellectual property contained therein.

UNLESS OTHERWISE SET FORTH IN ST'S TERMS AND CONDITIONS OF SALE ST DISCLAIMS ANY EXPRESS OR IMPLIED WARRANTY WITH RESPECT TO THE USE AND/OR SALE OF ST PRODUCTS INCLUDING WITHOUT LIMITATION IMPLIED WARRANTIES OF MERCHANTABILITY, FITNESS FOR A PARTICULAR PURPOSE (AND THEIR EQUIVALENTS UNDER THE LAWS OF ANY JURISDICTION), OR INFRINGEMENT OF ANY PATENT, COPYRIGHT OR OTHER INTELLECTUAL PROPERTY RIGHT.

UNLESS EXPRESSLY APPROVED IN WRITING BY AN AUTHORIZED ST REPRESENTATIVE, ST PRODUCTS ARE NOT RECOMMENDED, AUTHORIZED OR WARRANTED FOR USE IN MILITARY, AIR CRAFT, SPACE, LIFE SAVING, OR LIFE SUSTAINING APPLICATIONS, NOR IN PRODUCTS OR SYSTEMS WHERE FAILURE OR MALFUNCTION MAY RESULT IN PERSONAL INJURY, DEATH, OR SEVERE PROPERTY OR ENVIRONMENTAL DAMAGE. ST PRODUCTS WHICH ARE NOT SPECIFIED AS "AUTOMOTIVE GRADE" MAY ONLY BE USED IN AUTOMOTIVE APPLICATIONS AT USER'S OWN RISK.

Resale of ST products with provisions different from the statements and/or technical features set forth in this document shall immediately void any warranty granted by ST for the ST product or service described herein and shall not create or extend in any manner whatsoever, any liability of ST.

ST and the ST logo are trademarks or registered trademarks of ST in various countries.

Information in this document supersedes and replaces all information previously supplied.

The ST logo is a registered trademark of STMicroelectronics. All other names are the property of their respective owners.

© 2010 STMicroelectronics - All rights reserved

STMicroelectronics group of companies

Australia - Belgium - Brazil - Canada - China - Czech Republic - Finland - France - Germany - Hong Kong - India - Israel - Italy - Japan - Malaysia - Malta - Morocco - Philippines - Singapore - Spain - Sweden - Switzerland - United Kingdom - United States of America

www.st.com

