

Smart Fiber Amplifier Unit E3X-HD

CSM_E3X-HD_DS_E_6_1



Easy and optimum settings for anyone Smart Fiber Amplifier Unit with Long-term Stable Detection

- Equipped with Smart Tuning, which automatically configures the settings to their optimum values with the press of a single button.
- Highly usable design enables anyone to configure the settings easily.
- Detects dirt, vibrations, and LED deterioration, and automatically compensates the incident level and the light intensity.
- Unparalleled best-in-class power provides stable detections for low-reflective workpieces and large workpieces (equipped with GIGA RAY II).

Refer to the *Fiber Sensors Technical Guide and Safety Precautions* on page 9.



For the most recent information on models that have been certified for safety standards, refer to your OMRON website.

Features

Easy

Greater operability and visibility are realized by a universal design

Operations

Symbolic buttons are easy to remember anywhere even for operators overseas.



Compatibility for easy operation and incorrect operation prevention.



Pleasant operation even with gloves on.

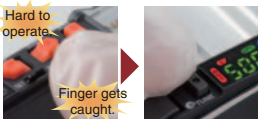

Conventional Models
Sliding switches

E3X-HD
Pushbutton switches
(no sliding switches)

Arc Design
A strong accent line gives a compact look to improve equipment design

Indications

Visibility is improved with digital displays and visible indicators. New Concept: Visible Indicators

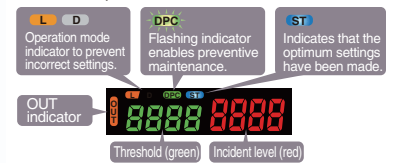

Smart Tuning

Smart tuning for the optimum settings with just one button.

Smart Tuning

Automatically configure the settings to their optimum values with the press of a single button.

With workpiece Without workpiece

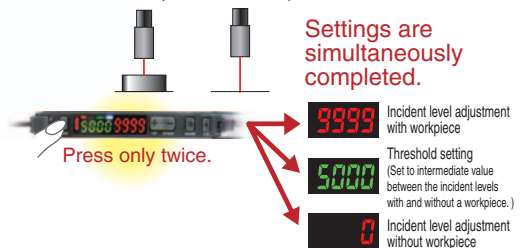

Stable

Long-term stable detection with no maintenance

Smart Power Control

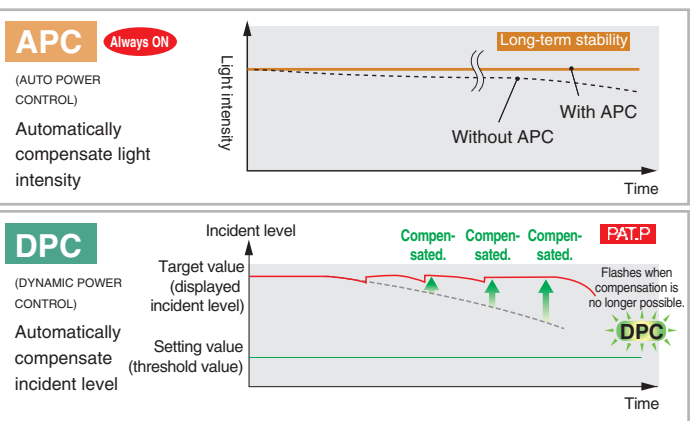
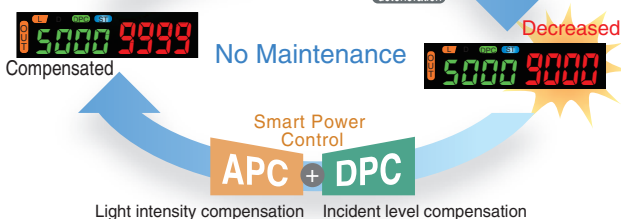

Maintenance-free operation by double compensation of light intensity and incident level



Ordering Information

Fiber Amplifier Units

Standard models (Dimensions → page 12)

Appearance	Connecting method	Models	
		NPN output	PNP output
	Pre-wired (2 m)	E3X-HD11 2M	E3X-HD41 2M
	Wire-saving Connector	E3X-HD6	E3X-HD8
	M8 Connector	E3X-HD14	E3X-HD44



Model for Sensor Communications Unit (Dimensions → page 12)

Appearance	Model	Applicable Sensor Communications Unit
	E3X-HD0	E3X-ECT E3X-CRT

Accessories (sold separately)



Wire-saving connectors (Required for models for Wire-saving Connectors.)

Connectors are not provided with the Fiber Amplifier Unit and must be ordered separately. * Protective stickers: provided.

Type	Appearance	Cable length	Number of conductors	Models
Master Connector		2 m	3	E3X-CN11
Slave Connector			1	E3X-CN12

Sensor I/O Connectors (Required for models with M8 Connectors.)

Connectors are not provided with the Fiber Amplifier Unit and must be ordered separately.

Size	Cable	Appearance	Cable type	Models	
M8	Standard	Straight 	2 m	4-wire	XS3F-M421-402-A
			5 m		XS3F-M421-405-A
		L-shaped 	2 m		XS3F-M422-402-A
			5 m		XS3F-M422-405-A

Mounting Bracket

A Mounting Bracket is not provided with the Fiber Amplifier Unit and must be ordered separately as required.

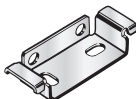
Appearance	Model	Quantity
	E39-L143	1

DIN Track

A Din Track is not provided with the Fiber Amplifier Unit and must be ordered separately as required.

Appearance	Type	Models	Quantity
	Shallow type, total length: 1 m	PFP-100N	1
	Shallow type, total length: 0.5 m	PFP-50N	
	Deep type, total length: 1 m	PFP-100N2	

End Plate

Two End Plates are provided with the Sensor Communications Unit. End Plates are not provided with the Fiber Amplifier Unit and must be ordered separately as required.

Appearance	Model	Quantity
	PFP-M	1

Ratings and Specifications

Item	Type	Standard			Model for Sensor Communications Unit *1
	NPN output	E3X-HD11	E3X-HD6	E3X-HD14	E3X-HD0
	PNP output	E3X-HD41	E3X-HD8	E3X-HD44	
	Connecting method	Pre-wired	Wire-saving Connector *2	M8 Connector	Connector for Sensor Communications Unit
Light source (wavelength)		Red, 4-element LED (625 nm)			
Power supply voltage		12 to 24 VDC ±10%, ripple (P-P) 10% max.			Supplied from the connector through the Sensor Communications Unit
Power consumption	Normal mode	720 mW max. (Current consumption: 30 mA max. at 24 VDC, 60 mA max. at 12 VDC)			
	Eco ON	530 mW max. (Current consumption: 22 mA max. at 24 VDC, 44 mA max. at 12 VDC)			
	Eco LO	640 mW max. (Current consumption: 26 mA max. at 24 VDC, 53 mA max. at 12 VDC)			–
Control output		Load power supply voltage: 26.4 VDC max., open-collector output Load current: Groups of 1 to 3 Amplifier Units: 100mA max., Groups of 4 to 16 Amplifier Units: 20mA max. Residual voltage: At load current of less than 10 mA: 1 V max., At load current of 10 to 100 mA: 2 V max. OFF current: 0.1 mA max.			–
Protection circuits		Power supply reverse polarity protection, output short-circuit protection and output reverse polarity protection			Power supply reverse polarity protection and output short-circuit protection
Response time	Super-high-speed mode (SHS) *3	NPN outputs: Operate or reset: 50 μs PNP outputs: Operate or reset: 55 μs			–
	High-speed mode (HS)	Operate or reset: 250 μs (default setting)			
	Standard mode (Std)	Operate or reset: 1 ms			
	Giga-power mode (GIGA)	Operate or reset: 16 ms			
Maximum connectable Units		16 units			with E3X-CRT: 16 units with E3X-ECT: 30 units
Mutual interference prevention		Possible for up to 10 units (optical communications sync) *3			
Auto power control (APC)		Always ON			
Other functions		Power tuning, differential detection, DPC, timer (OFF-delay, ON-delay, or one-shot), zero reset, resetting settings, and Eco mode			
Ambient illumination (Receiver side)		Incandescent lamp: 20,000 lx max., Sunlight: 30,000 lx max.			
Ambient temperature range		Operating: Groups of 1 to 2 Amplifiers: –25 to 55°C, Groups of 3 to 10 Amplifiers: –25 to 50°C, Groups of 11 to 16 Amplifiers: –25 to 45°C Storage: –30 to 70°C (with no icing or condensation)			Operating: Groups of 1 to 2 Amplifiers: 0 to 55°C, Groups of 3 to 10 Amplifiers: 0 to 50°C, Groups of 11 to 16 Amplifiers: 0 to 45°C, Groups of 17 to 30 Amplifiers: 0 to 40°C Storage: –30 to 70°C (with no icing or condensation)
Ambient humidity range		Operating and storage: 35% to 85% (with no condensation)			
Insulation resistance		20 MΩ min. (at 500 VDC)			
Dielectric strength		1,000 VAC at 50/60 Hz for 1 minute			
Vibration resistance (destruction)		10 to 55 Hz with a 1.5-mm double amplitude for 2 hours each in X, Y, and Z directions		10 to 150 Hz with a 0.7-mm double amplitude for 80 minutes each in X, Y, and Z directions	
Shock resistance (destruction)		500 m/s ² for 3 times each in X, Y, and Z directions			150 m/s ² for 3 times each in X, Y, and Z directions
Degree of protection		IEC 60529 IP50 (with Protective Cover attached)			
Weight (packed state/unit only)		Approx. 105 g/ Approx. 65 g	Approx. 60 g/ Approx. 20 g	Approx. 70 g/ Approx. 25 g	Approx. 65 g/Approx. 25 g
Materials	Case	Polycarbonate (PC)			Heat-resistant ABS (connector: PBT)
	Cover	Polycarbonate (PC)			
Accessories		Instruction Manual			

*1. The E3X-ECT EtherCAT Sensor Communications Unit and the E3X-CRT CompoNet Sensor Communications Unit can be used.

*2. Use either the E3X-CN11 (master connector, 3 conductors) or the E3X-CN12 (slave connector, 1 conductor).

*3. The communications function and mutual interference prevention function are disabled when the detection mode is set to Super-high-speed mode (SHS).
When including E3X-DA-S with activated power tuning, mutual interference prevention is possible for up to 6 units.
When including E3X-MDA with activated power tuning, mutual interference prevention is possible for up to 5 units.

Sensing Distances

Threaded Models

Sensing method	Sensing direction	Size	Model	Sensing distance (mm)			
				Giga mode	Standard mode	High-speed mode	Super-high-speed mode
Through-beam	Right-angle	M4	E32-T11N 2M	2,000	1,000	700	280
			E32-LT11N 2M	4,000 *	3,500	2,300	920
	Straight		E32-T11R 2M	2,000	1,000	700	280
			E32-LT11 2M	4,000 *	4,000 *	2,700	1,080
			E32-LT11R 2M	4,000 *	3,500	2,300	920
Reflective	Right-angle	M3	E32-C31N 2M	110	50	46	14
			E32-C21N 2M	290	130	90	39
		M4	E32-D21N 2M	840	350	240	100
			E32-C11N 2M	780	350	320	100
		M6	E32-LD11N 2M	840	350	240	100
			E32-D21R 2M	140	60	40	16
	Straight	M3	E32-C31 2M	330	150	100	44
			E32-C31M 1M				
			M4	E32-D211R 2M	140	60	40
		E32-D11R 2M		840	350	240	100
		M6	E32-CC200 2M	1,400	600	400	180
			E32-LD11 2M	860	360	250	110
			E32-LD11R 2M	840	350	240	100

* The fiber length is 2 m on each side, so the sensing distance is given as 4,000 mm.

Cylindrical Models

Sensing method	Size	Sensing direction	Model	Sensing distance (mm)			
				Giga mode	Standard mode	High-speed mode	Super-high-speed mode
Through-beam	1 dia.	Top-view	E32-T223R 2M	450	250	150	60
	1.5 dia.		E32-T22B 2M	680	400	220	90
	3 dia.		E32-T12R 2M	2,000	1,000	700	280
		Side-view	E32-T14LR 2M	750	450	260	100
Reflective	1.5 dia.	Top-view	E32-D22B 2M	140	60	40	16
	1.5 dia. + 0.5 dia.		E32-D43M 1M	28	12	8	4
	3 dia.		E32-D22R 2M	140	60	40	16
			E32-D221B 2M	300	140	90	40
			E32-D32L 2M	700	300	200	90
	3 dia. + 0.8 dia.		E32-D33 2M	70	30	20	8

Flat Models

Sensing method	Sensing direction	Model	Sensing distance (mm)			
			Giga mode	Standard mode	High-speed mode	Super-high-speed mode
Through-beam	Top-view	E32-T15XR 2M	2,000	1,000	700	280
	Side-view	E32-T15YR 2M	750	450	260	100
	Flat-view	E32-T15ZR 2M				
Reflective	Top-view	E32-D15XR 2M	840	350	240	100
	Side-view	E32-D15YR 2M	200	100	52	24
	Flat-view	E32-D15ZR 2M				

Sleeve Models

Sensing method	Sensing direction	Model	Sensing distance (mm)			
			Giga mode	Standard mode	High-speed mode	Super-high-speed mode
Through-beam	Side-view	E32-T24R 2M	170	100	50	20
		E32-T24E 2M	450	250	150	60
	Top-view	E32-T33 1M	150	90	50	20
		E32-T21-S1 2M	510	300	170	68
		E32-TC200BR 2M	2,000	1,000	700	280
Reflective	Side-view	E32-D24R 2M	70	30	20	8
		E32-D24-S2 2M	120	53	45	14
	Top-view	E32-D43M 1M	28	12	8	4
		E32-D331 2M	14	6	4	2
		E32-D33 2M	70	30	20	8
		E32-D32-S1 0.5M	63	27	18	7
		E32-D31-S1 0.5M				
		E32-DC200F4R 2M	140	60	40	16
		E32-D22-S1 2M	250	110	72	30
		E32-D21-S3 2M				
		E32-DC200BR 2M	840	350	240	100
		E32-D25-S3 2M	250	110	72	30

Small-spot, Reflective Models

Type	Spot diameter	Center distance (mm)	Model	Sensing distance (mm)			
				Giga mode	Standard mode	High-speed mode	Super-high-speed mode
Variable spot	0.1 to 0.6 dia.	6 to 15	E32-C42 1M+E39-F3A	Spot diameter of 0.1 to 0.6 mm at 6 to 15 mm.			
	0.3 to 1.6 dia.	10 to 30	E32-C42 1M+E39-F17	Spot diameter of 0.3 to 1.6 mm at 10 to 30 mm.			
Parallel light	4 dia.	0 to 20	E32-C31 2M+E39-F3C	Spot diameter of 4 mm max. at 0 to 20 mm.			
			E32-C31N 2M+E39-F3C				
Integrated lens	0.1 dia.	5	E32-C42S 1M	Spot diameter of 0.1 mm at 5 mm.			
	6 dia.	50	E32-L15 2M	Spot diameter of 6 mm at 50 mm.			
Small-spot	0.1 dia.	7	E32-C41 1M+E39-F3A-5	Spot diameter of 0.1 mm at 7 mm.			
			E32-C31 2M+E39-F3A-5	Spot diameter of 0.5 mm at 7 mm.			
	0.5 dia.	17	E32-C31N 2M+E39-F3A-5				
	0.2 dia.		E32-C41 1M+E39-F3B	Spot diameter of 0.2 mm at 17 mm.			
		0.5 dia.	E32-C31 2M+E39-F3B	Spot diameter of 0.5 mm at 17 mm.			
	E32-C31N 2M+E39-F3B						
3 dia.	50	E32-CC200 2M+E39-F18	Spot diameter of 3 mm at 50 mm.				
		E32-C11N 2M+E39-F18					

High-power Beam Models

Type	Sensing direction	Aperture angle	Model	Sensing distance (mm)			
				Giga mode	Standard mode	High-speed mode	Super-high-speed mode
Through-beam models with integrated lens	Right-angle	15°	E32-LT11N 2M	4,000 *2	3,500	2,300	920
		10°	E32-T17L 10M	20,000 *1	20,000 *1	20,000 *1	8,000
	Top-view	15°	E32-LT11 2M	4,000 *2	4,000 *2	2,700	1,080
		E32-LT11R 2M	4,000 *2	3,500	2,300	920	
Side-view	30°	E32-T14 2M	4,000 *2	4,000 *2	4,000 *2	1,800	
Through-beam models with lenses	Right-angle	12°	E32-T11N 2M+E39-F1	4,000 *2	4,000 *2	4,000 *2	2,000
		6°	E32-T11N 2M+E39-F16	4,000 *2	4,000 *2	4,000 *2	3,600
	Top-view	12°	E32-T11R 2M+E39-F1	4,000 *2	4,000 *2	4,000 *2	2,000
		6°	E32-T11R 2M+E39-F16	4,000 *2	4,000 *2	4,000 *2	3,600
	Side-view	60°	E32-T11R 2M+E39-F2	1,450	800	500	200
	Top-view	12°	E32-T11 2M+E39-F1	4,000 *2	4,000 *2	4,000 *2	1,860
		6°	E32-T11 2M+E39-F16	4,000 *2	4,000 *2	4,000 *2	4,000 *2
	Side-view	60°	E32-T11 2M+E39-F2	2,300	1,320	860	320
	Top-view	12°	E32-T51R 2M+E39-F1	4,000 *2	4,000 *2	3,900	1,500
		6°	E32-T51R 2M+E39-F16	4,000 *2	4,000 *2	4,000 *2	4,000 *2
	Side-view	60°	E32-T51R 2M+E39-F2	1,400	720	500	200
	Top-view	12°	E32-T81R-S 2M+E39-F1	4,000 *2	4,000 *2	2,700	1,000
		6°	E32-T81R-S 2M+E39-F16	4,000 *2	4,000 *2	4,000 *2	1,800
	Side-view	60°	E32-T81R-S 2M+E39-F2	1,000	550	360	140
	Top-view	12°	E32-T61-S 2M+E39-F1	4,000 *2	4,000 *2	4,000 *2	1,800
		6°	E32-T61-S 2M+E39-F16	4,000 *2	4,000 *2	4,000 *2	3,100
Side-view	60°	E32-T61-S 2M+E39-F2	1,680	900	600	240	
Top-view	12°	E32-T51 2M+E39-F1-33	4,000 *2	4,000 *2	2,300	1,400	
	6°	E32-T51 2M+E39-F16	4,000 *2	4,000 *2	4,000 *2	4,000 *2	
Reflective models with integrated lens	Top-view	4°	E32-D16 2M	40 to 2,800	40 to 1,400	40 to 900	40 to 480

*1. The fiber length is 10 m on each side, so the sensing distance is given as 20,000 mm.

*2. The fiber length is 2 m on each side, so the sensing distance is given as 4,000 mm.

Narrow View Models

Sensing method	Sensing direction	Aperture angle	Model	Sensing distance (mm)			
				Giga mode	Standard mode	High-speed mode	Super-high-speed mode
Through-beam	Side-view	1.5°	E32-A03 2M	3,220	1,780	1,200	500
			E32-A03-1 2M				
		3.4°	E32-A04 2M	1,280	680	450	200
		4°	E32-T24SR 2M	4,000 *	2,200	1,460	580
			E32-T24S 2M	4,000 *	2,600	1,740	700
E32-T22S 2M	4,000 *	3,800	2,500	1,000			

* The fiber length is 2 m on each side, so the sensing distance is given as 4,000 mm.

Models for Detection without Background Interference

Sensing method	Sensing direction	Model	Sensing distance (mm)			
			Giga mode	Standard mode	High-speed mode	Super-high-speed mode
Limited-reflective	Flat-view	E32-L16-N 2M	0 to 15			0 to 12
		E32-L24S 2M	0 to 4			
	Side-view	E32-L25L 2M	5.4 to 9 (center 7.2)			

Transparent Object Detection (Retro-reflective Models)

Sensing method	Feature	Size	Model	Sensing distance (mm)			
				Giga mode	Standard mode	High-speed mode	Super-high-speed mode
Retro-reflective	Film detection	M3	E32-C31 2M +E39-F3R +E39-RP37	250		200	---
	Square	---	E32-R16 5M	150 to 1,500			
	Threaded	M6	E32-R21 2M	10 to 250			
	Hex-shaped		E32-LR11NP 2M +E39-RP1	1,350	1,200	1,000	550

Transparent Object Detection (Limited-reflective Models)

Sensing method	Feature	Sensing direction	Model	Sensing distance (mm)			
				Giga mode	Standard mode	High-speed mode	Super-high-speed mode
Limited-reflective	Small size	Flat-view	E32-L24S 2M	0 to 4			
	Standard		E32-L16-N 2M	0 to 15			0 to 12
	Glass substrate alignment, 70°C		E32-A08 2M	10 to 20			---
	Standard/long-distance	E32-A12 2M	12 to 30			---	
	Side-view form	Side-view	E32-L25L 2M	5.4 to 9 (center 7.2)			
	Glass substrate mapping, 70°C	Top-view	E32-A09 2M	15 to 38			---

Chemical-resistant, Oil-resistant Models

Sensing method	Type	Sensing direction	Model	Sensing distance (mm)			
				Giga mode	Standard mode	High-speed mode	Super-high-speed mode
Through-beam	Oil-resistant	Right-angle	E32-T11NF 2M	4,000 *1	4,000 *1	4,000 *1	2,200
	Chemical/oil-resistant	Top-view	E32-T12F 2M	4,000 *1	4,000 *1	4,000 *1	1,600
		Side-view	E32-T11F 2M	4,000 *1	4,000 *1	2,600	1,000
			E32-T14F 2M	1,400	800	500	200
Chemical/oil-resistant at 150°C	Top-view	E32-T51F 2M	4,000 *1	2,800	1,800	700	
Reflective	Semiconductors: Cleaning, developing, and etching; 60°C	Top-view	E32-L11FP 5M	8 to 20 mm from tip of lens (Recommended sensing distance: 11 mm), 19 to 31 mm from center of mounting hole A (Recommended sensing distance: 22 mm)			
	Semiconductors: Resist stripping; 85°C		E32-L11FS 5M	8 to 20 mm from tip of lens (Recommended sensing distance: 11 mm), 32 to 44 mm from center of mounting hole A (Recommended sensing distance: 35 mm)			
	Chemical/oil-resistant		E32-D12F 2M	---	190	130	60
	Chemical-resistant cable		E32-D11U 2M	840	350	240	100

*1. The fiber length is 2 m on each side, so the sensing distance is given as 4,000 mm.

*2. Even if there is no sensing object, the Sensor will detect light that is reflected by the fluorescein.

Bending-resistant Models

Sensing method	Size	Model	Sensing distance (mm)			
			Giga mode	Standard mode	High-speed mode	Super-high-speed mode
Through-beam	1.5 dia.	E32-T22B 2M	680	400	220	90
	M3	E32-T21 2M				
	M4	E32-T11 2M	2,500	1,350	900	360
	Square	E32-T25XB 2M	500	300	170	70
Reflective	1.5 dia.	E32-D22B 2M	140	60	40	16
	M3	E32-D21 2M				
	3 dia.	E32-D221B 2M	300	140	90	40
	M4	E32-D21B 2M				
	M6	E32-D11 2M	840	350	240	100
	Square	E32-D25XB 2M	240	100	60	30

Heat-resistant Models

Sensing method	Size	Model	Sensing distance (mm)				
			Giga mode	Standard mode	High-speed mode	Super-high-speed mode	
Through-beam	100°C	E32-T51R 2M	1,600	800	560	225	
	150°C	E32-T51 2M	2,800	1,500	1,000	400	
	200°C	E32-T81R-S 2M	1,000	550	360	140	
	350°C	E32-T61-S 2M	1,680	900	600	240	
Reflective	100°C	E32-D51R 2M	670	280	190	80	
	150°C	E32-D51 2M	1,120	450	320	144	
	200°C	E32-D81R-S 2M	420	180	120	54	
	300°C	E32-A08H2 2M	10 to 20				---
		E32-A09H2 2M	20 to 30 (center 25)				---
	350°C	E32-D611-S 2M	420	180	120	54	
		E32-D61-S 2M					
	400°C	E32-D73-S 2M	280	120	80	36	

Area Detection Models

Sensing method	Type	Sensing width	Model	Sensing distance (mm)			
				Giga mode	Standard mode	High-speed mode	Super-high-speed mode
Through-beam	Area	11 mm	E32-T16PR 2M	3,100	1,700	1,120	440
			E32-T16JR 2M	2,750	1,500	960	380
		30 mm	E32-T16WR 2M	4,000 *	2,600	1,700	680
Reflective	Array	11 mm	E32-D36P1 2M	700	300	200	90

* The fiber length is 2 m on each side, so the sensing distance is given as 4,000 mm.

Liquid-level Detection Models

Sensing method	Tube diameter	Feature	Model	Sensing distance (mm)			
				Giga mode	Standard mode	High-speed mode	Super-high-speed mode
Tube-mounting	3.2, 6.4, or 9.5 dia.	Stable residual quantity detection	E32-A01 5M	Applicable tube: Transparent tube with a diameter of 3.2, 6.4, or 9.5 mm, Recommended wall thickness: 1 mm			
	8 to 10 dia.	Mounting at multiple levels	E32-L25T 2M	Applicable tube: Transparent tube with a diameter of 8 to 10 mm, Recommended wall thickness: 1 mm			
	No restrictions	Large tubes	E32-D36T 5M	Applicable tube: Transparent tube (no restrictions on diameter)			
Liquid contact (heat-resistant up to 200°C)	---	---	E32-D82F1 4M	Liquid-contact type			

Vacuum-resistant Models

Sensing method	Heat-resistant temperature	Model	Sensing distance (mm)			
			Giga mode	Standard mode	High-speed mode	Super-high-speed mode
Through-beam	120°C	E32-T51V 1M	720	400	260	100
		E32-T51V 1M+E39-F1V	2,000 *	2,000 *	1,360	520
	200°C	E32-T84SV 1M	1,760	950	640	260

* The fiber length is 1 m on each side, so the sensing distance is given as 2,000 mm.

Models for FPD, Semiconductors, and Solar Cells

Sensing method	Application	Operating temperature	Model	Sensing distance (mm)			
				Giga mode	Standard mode	High-speed mode	Super-high-speed mode
Limited-reflective	Glass presence detection	70°C	E32-L16-N 2M	0 to 15			0 to 12
	Glass substrate alignment		E32-A08 2M	10 to 20			---
		Glass substrate mapping	300°C	E32-A08H2 3M	12 to 30		
	Wet processes: Cleaning, Resist developing and etching		70°C	E32-A12 2M	15 to 38		
		Wet process: Resist stripping	300°C	E32-A09 2M	20 to 30 (center 25)		
	Through-beam		Wafer mapping	60°C	E32-L11FP 5M	8 to 20 mm from tip of lens (Recommended sensing distance: 11 mm), 19 to 31 mm from center of mounting hole A (Recommended sensing distance: 22 mm)	
85°C		E32-L11FS 5M		8 to 20 mm from tip of lens (Recommended sensing distance: 11 mm), 32 to 44 mm from center of mounting hole A (Recommended sensing distance: 35 mm)			
70°C		E32-A03 2M	3,220	1,780	1,200	500	
		E32-A03-1 2M					
		E32-A04 2M	1,280	680	450	200	
E32-T24SR 2M	4,000 *	2,200	1,460	580			
	E32-T24S 2M	4,000 *	2,600	1,740	700		

* The fiber length is 2 m on each side, so the sensing distance is given as 4,000 mm.

I/O Circuit Diagrams

NPN Output

Models	Operation mode	Timing chart	L/D indicators	Output circuit
E3X-HD11 E3X-HD6 E3X-HD14	Light-ON		L lit.	<p>• M8 Connector Pin Arrangement</p> <p>Note: Pin 2 is not used.</p>
	Dark-ON		D lit.	

PNP Output

Models	Operation mode	Timing chart	L/D indicators	Output circuit
E3X-HD41 E3X-HD8 E3X-HD44	Light-ON		L lit.	<p>• M8 Connector Pin Arrangement</p> <p>Note: Pin 2 is not used.</p>
	Dark-ON		D lit.	

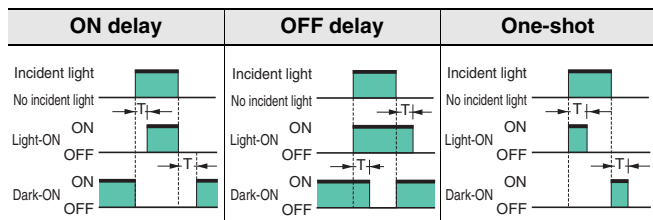

Note: Timing Charts for Timer Settings (T: Set Time)

Plug (Sensor I/O Connector)

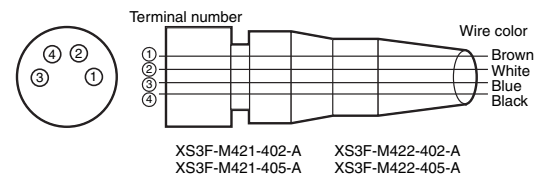

Wire color	Connection pin	Application
Brown	1	Power supply (+V)
White	2	---
Blue	3	Power supply (0 V)
Black	4	Output

Note: Pin 2 is not used.

Nomenclature

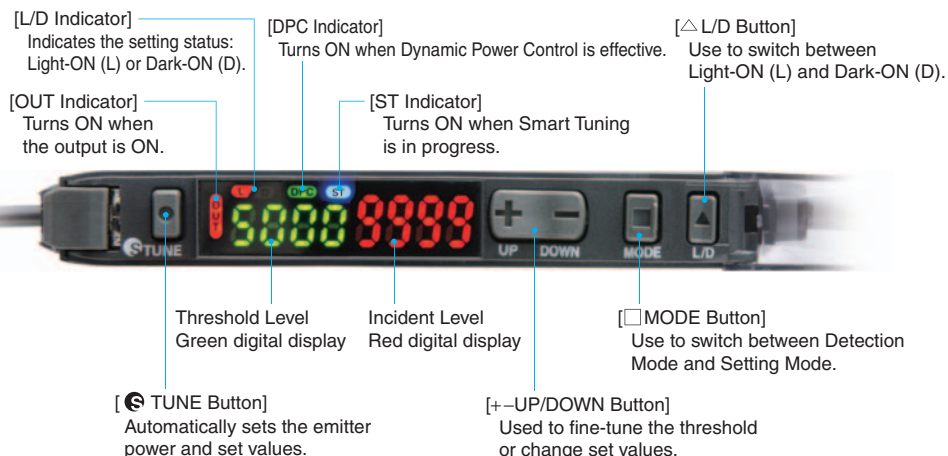

Safety Precautions

Refer to the *Fiber Sensors Technical Guide* for precautions that apply to all Fiber Sensors.

Warning

This product is not designed or rated for ensuring safety of persons either directly or indirectly. Do not use it for such purposes.



Do not use the product with voltage in excess of the rated voltage. Excess voltage may result in malfunction or fire.



Never use the product with AC power supply. Otherwise, explosion may result.



Precautions for Safe Use

The following precautions must be observed to ensure safe operation of the product. Doing so may cause damage or fire.

1. Do not install the product in the following locations.
 - Locations subject to direct sunlight
 - Locations subject to condensation due to high humidity
 - Locations subject to corrosive gas
 - Locations subject to vibration or mechanical shocks exceeding the rated values
 - Locations subject to exposure to water, oil, chemicals
 - Locations subject to stream
 - Locations subjected to strong magnetic field or electric field
2. Do not use the product in environments subject to flammable or explosive gases.
3. To secure the safety of operation and maintenance, do not install the product close to high-voltage devices and power devices.
4. High-Voltage lines and power lines must be wired separately from this product. Wiring them together or placing them in the same duct may cause induction, resulting in malfunction or damage.
5. Do not apply load exceeding the ratings. Otherwise, damage or fire may result.
6. Do not short the load. Otherwise, damage or fire may result.
7. Connect the load correctly.
8. Do not miswire such as the polarity of the power supply.
9. Do not use the product if the case is damaged.
10. Burn injury may occur. The product surface temperature rises depending on application conditions, such as the ambient temperature and the power supply voltage. Attention must be paid during operation or cleaning.
11. When setting the Sensor, be sure to check safety, such as by stopping the equipment.
12. Be sure to turn off the power supply before connecting or disconnecting wires.
13. Do not attempt to disassemble, repair, or modify the product Unit in any way.
14. When disposing of the product, treat it as industrial waste.
15. Do not use the Sensor in water, rainfall, or outdoors.

Precautions for Correct Use

- Be sure to mount the unit to the DIN track until it clicks.
- Use an extension cable with a minimum thickness of 0.3 mm² and less than 100 m long.
- Do not subject the cable to more than the following forces. Pull: 40 N; torque: 0.1 N·m; pressure: 20 N; bending: 29.4 N
- The Sensor is ready to operate 200 ms after the power supply is turned ON.
- When using Amplifier Units with Wire-saving Connectors, attach the protective stickers (provided with E3X-CN-series Connectors) on the unused power pins to prevent electrical shock and short circuiting.

When using Amplifier Units with Connectors for Communications Units, attach the protective caps (provided with E3X-CRT/ECT Sensor Communications Unit).

Amplifier Unit with Wire-saving Connector

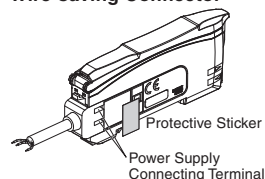

Amplifier Unit with Connector for Communications Unit



- Output pulses may occur when the power supply is turned OFF. Turn OFF the power supply to the load or load line first.
- Excessive incident light cannot be sufficiently handled by the mutual interference prevention function and may cause malfunction. To prevent this, set a higher threshold level.
- Make sure that the power supply is turned OFF before connecting, separating, or adding Amplifier Units.
- Do not pull on or apply excessive pressure or force to the Fiber Unit when it is attached to the Amplifier Unit.
- The E3X-MC11, E3X-MC11-SV2 and E3X-MC11-S Mobile Consoles cannot be used.
- Mutual interference prevention on the E3X-HD Series does not function among the E3NX-FA, E3X-DA-N, E3X-SD, or E3X-NA Fiber Amplifier Units. Mutual interference prevention on the E3X-HD Series does function among the E3X-DA-S and E3X-MDA Fiber Amplifier Units.
- The E3X-CRT and E3X-ECT Sensor Communications Unit can be used with the E3X-HD0, but the E3X-DRT21-S and E3NW-ECT Sensor Communications Units cannot be used.
- Always keep the protective cover in place when using the Amplifier Unit.
- Do not use thinner, benzene, acetone, and kerosene for cleaning.

For technical information and product FAQs, refer to the *Technical Guide* on your OMRON website.

Mounting the Fiber Amplifier Units

■ Mounting on DIN Track

- Let the hook on the Amplifier Unit's Fiber Unit connection side catch the track and push the unit until it clicks.

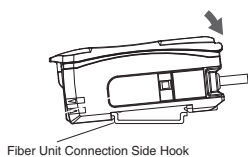

■ Removing from DIN Track

- Push the unit in the direction 1.
- Lift it up in the direction 2.

Note: Refer to *I/O Circuit Diagrams* or check the side of the unit for wire color and role indications.

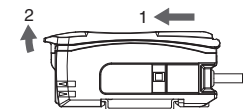

■ Mounting Amplifier Units in Group (Connector Type Models)

- Mount the Fiber Amplifier units one at a time onto the DIN track and push them until they click.
- Slide the Fiber Amplifier units in the direction 2.
- Use End Plates (PFP-M: separately sold) at the both ends of the grouped Fiber Amplifier units to prevent them from separating due to vibration or other cause.
- Tighten the screw on the End Plates using a driver.

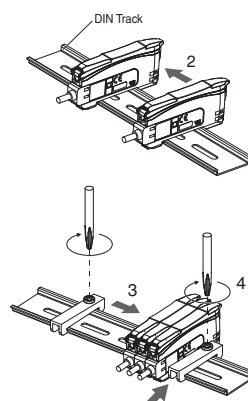

Tighten the screw while pressing the End Plate.

- Under environments such as vibration, use an end plates even with a single Fiber Amplifier Unit.
- The maximum numbers of connectable Amplifier Units are given in the following table.

	Maximum number of interconnected	Maximum number of mutual interference prevention
E3X-HD series standard models (E3X-HD11/HD41/HD6/HD8)	16	10
E3X-HD0	With E3X-ECT	30
	With E3X-CRT	16

- The mutual interference prevention function cannot be used if the detection mode is set to super-high-speed mode (SHS).
- If Units are to be connected, the allowable ambient temperature will change with the number of Units that are connected. Check the Ratings and Specifications.
- Always turn OFF the power before connecting or disconnecting Units.

Mounting Fiber Units

■ Use Fiber Cutter

Cut a thin fiber as follows.
For standard fibers, insert to the desired cutting position and cut.

1.	The fiber is shipped loosely tightened as shown in the figure at the right.	 Thin Fiber Attachment (E39-F9) Loosely tighten.
2.	Adjust the fiber to the desired length and fully tighten.	
3.	Insert the Fiber Unit into E39-F4 and cut it.	 Fiber Cutter E39-F4 Standard Fiber Unit Hole (dia. 2.2 mm) x 3 Thin-diameter Fiber Unit Hole x 2
4.	Finished state. (Correctly cut end)	 About 0.5 mm Insertion direction Note: The insertion direction into the Fiber Amplifier Unit is shown in the above figure.

■ Mount Fiber Unit

- Open the protective cover.
- Raise the lock lever.
- Insert the Fiber Unit in the fiber unit hole to the bottom.
- Return the lock lever to the original position and fix the Fiber Unit.

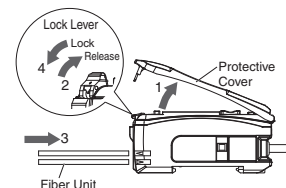

- When mounting a coaxial reflective Fiber Unit, insert the single-core Fiber Unit to the upper hole (Emitter side) and the multi-core Fiber Unit to the lower hole (Receiver side). The cables for the Single-core Fiber Units (Emitters) have identification marks. Refer to the dimensions diagrams for details.

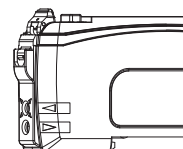

- When removing the Fiber Unit, follow the above steps in reverse order. To maintain the characteristics of the Fiber Unit, make sure the lock is released before removing the Fiber Unit.

Dimensions

Fiber Amplifier Units

Pre-wired Amplifier Units

E3X-HD11

E3X-HD41

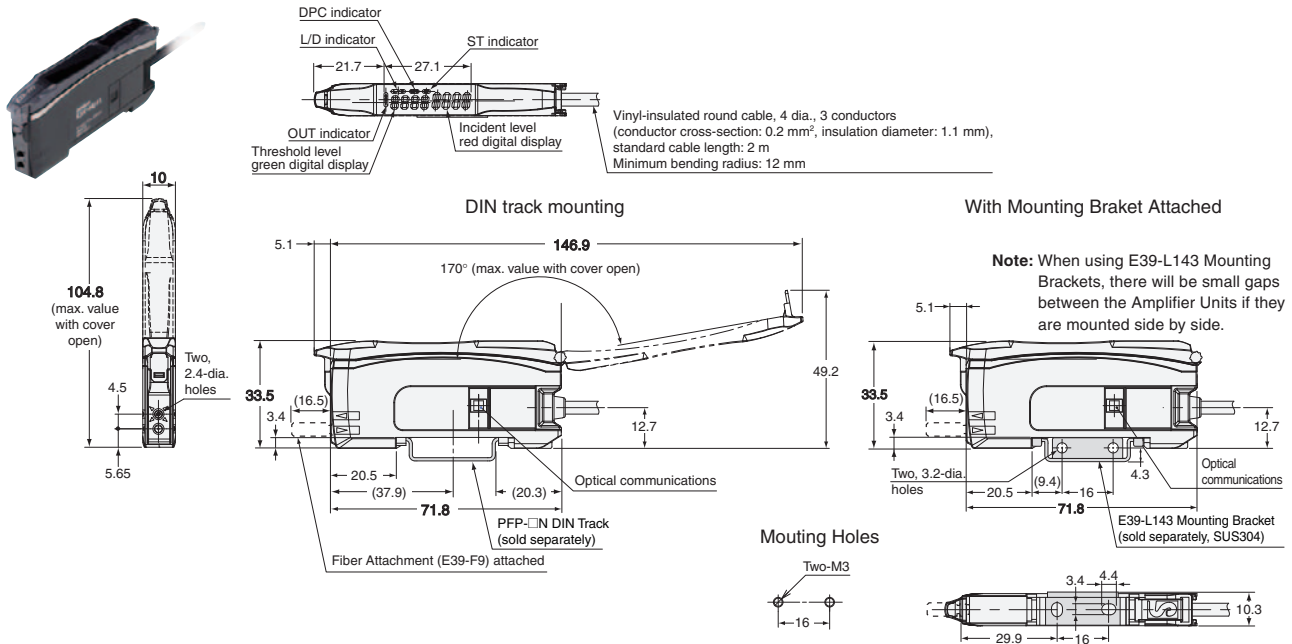

Amplifier Units with Wire-saving Connectors

E3X-HD6

E3X-HD8

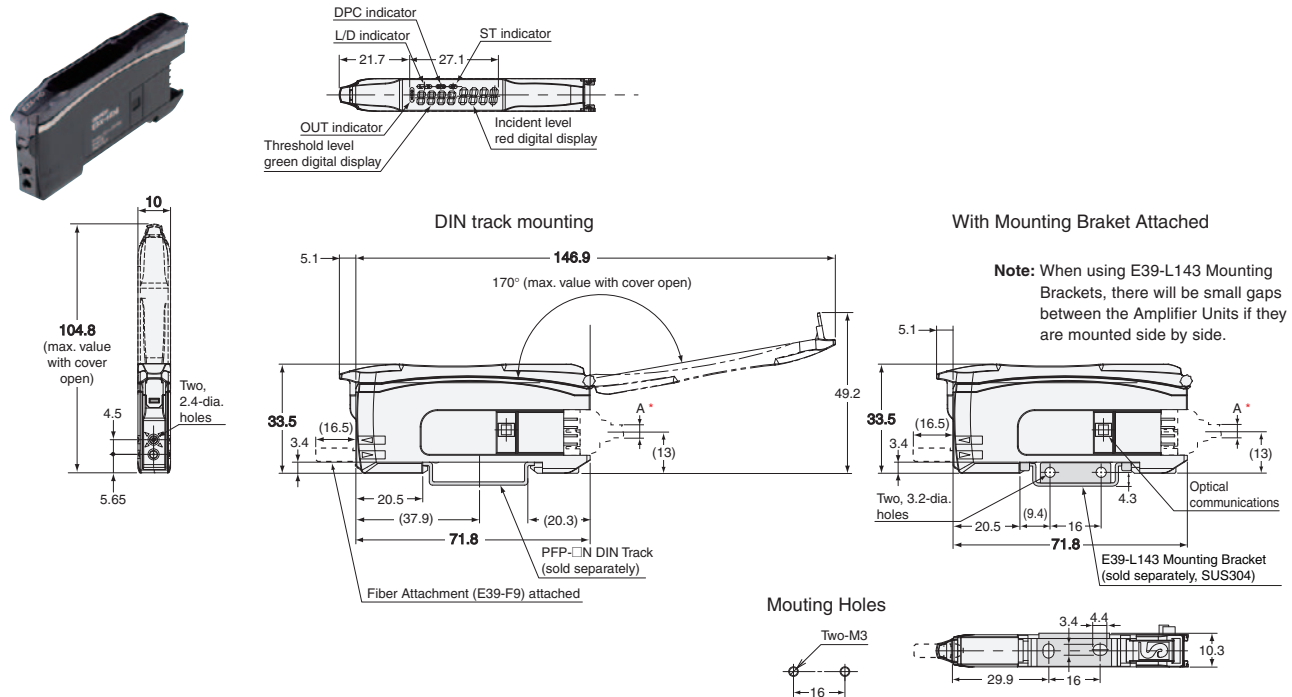

* The cable diameters are as follows:

E3X-CN11 (3 conductors)	4.0 dia.
E3X-CN12 (1 conductor)	2.6 dia.

Amplifier Units with M8 Connectors

E3X-HD14
E3X-HD44

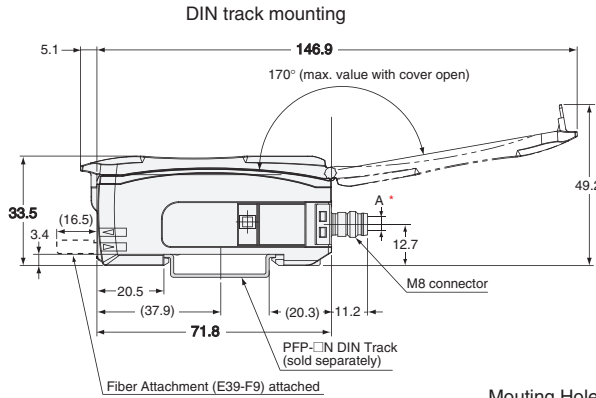
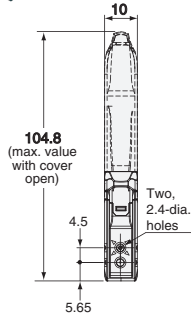
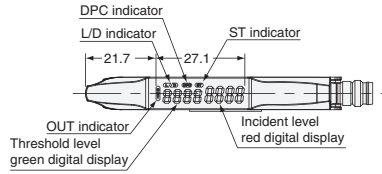

With Mounting Bracket Attached

Note: When using E39-L143 Mounting Brackets, there will be small gaps between the Amplifier Units if they are mounted side by side.

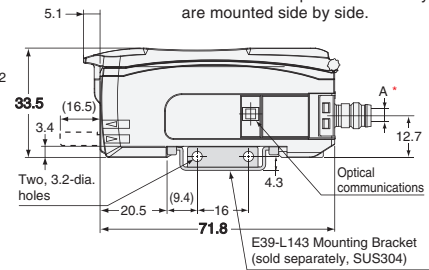

Mounting Holes

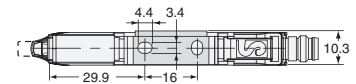

* The cable diameters are as follows:

E3X-CN11 (3 conductors)	4.0 dia.
E3X-CN12 (1 conductor)	2.6 dia.

Amplifier Unit with Connector for Sensor Communications Unit

E3X-HD0

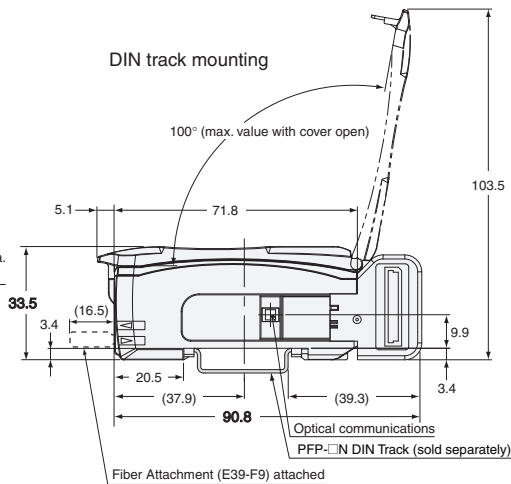
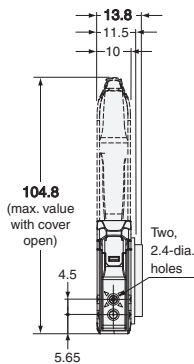
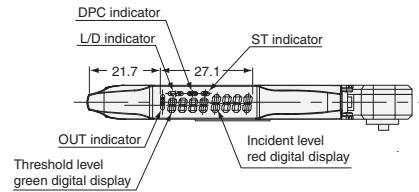

Refer to E32 Series for details on Fiber Units.

Terms and Conditions Agreement

Read and understand this catalog.

Please read and understand this catalog before purchasing the products. Please consult your OMRON representative if you have any questions or comments.

Warranties.

(a) Exclusive Warranty. Omron's exclusive warranty is that the Products will be free from defects in materials and workmanship for a period of twelve months from the date of sale by Omron (or such other period expressed in writing by Omron). Omron disclaims all other warranties, express or implied.

(b) Limitations. OMRON MAKES NO WARRANTY OR REPRESENTATION, EXPRESS OR IMPLIED, ABOUT NON-INFRINGEMENT, MERCHANTABILITY OR FITNESS FOR A PARTICULAR PURPOSE OF THE PRODUCTS. BUYER ACKNOWLEDGES THAT IT ALONE HAS DETERMINED THAT THE PRODUCTS WILL SUITABLY MEET THE REQUIREMENTS OF THEIR INTENDED USE.

Omron further disclaims all warranties and responsibility of any type for claims or expenses based on infringement by the Products or otherwise of any intellectual property right. (c) Buyer Remedy. Omron's sole obligation hereunder shall be, at Omron's election, to (i) replace (in the form originally shipped with Buyer responsible for labor charges for removal or replacement thereof) the non-complying Product, (ii) repair the non-complying Product, or (iii) repay or credit Buyer an amount equal to the purchase price of the non-complying Product; provided that in no event shall Omron be responsible for warranty, repair, indemnity or any other claims or expenses regarding the Products unless Omron's analysis confirms that the Products were properly handled, stored, installed and maintained and not subject to contamination, abuse, misuse or inappropriate modification. Return of any Products by Buyer must be approved in writing by Omron before shipment. Omron Companies shall not be liable for the suitability or unsuitability or the results from the use of Products in combination with any electrical or electronic components, circuits, system assemblies or any other materials or substances or environments. Any advice, recommendations or information given orally or in writing, are not to be construed as an amendment or addition to the above warranty.

See <http://www.omron.com/global/> or contact your Omron representative for published information.

Limitation on Liability; Etc.

OMRON COMPANIES SHALL NOT BE LIABLE FOR SPECIAL, INDIRECT, INCIDENTAL, OR CONSEQUENTIAL DAMAGES, LOSS OF PROFITS OR PRODUCTION OR COMMERCIAL LOSS IN ANY WAY CONNECTED WITH THE PRODUCTS, WHETHER SUCH CLAIM IS BASED IN CONTRACT, WARRANTY, NEGLIGENCE OR STRICT LIABILITY.

Further, in no event shall liability of Omron Companies exceed the individual price of the Product on which liability is asserted.

Suitability of Use.

Omron Companies shall not be responsible for conformity with any standards, codes or regulations which apply to the combination of the Product in the Buyer's application or use of the Product. At Buyer's request, Omron will provide applicable third party certification documents identifying ratings and limitations of use which apply to the Product. This information by itself is not sufficient for a complete determination of the suitability of the Product in combination with the end product, machine, system, or other application or use. Buyer shall be solely responsible for determining appropriateness of the particular Product with respect to Buyer's application, product or system. Buyer shall take application responsibility in all cases.

NEVER USE THE PRODUCT FOR AN APPLICATION INVOLVING SERIOUS RISK TO LIFE OR PROPERTY OR IN LARGE QUANTITIES WITHOUT ENSURING THAT THE SYSTEM AS A WHOLE HAS BEEN DESIGNED TO ADDRESS THE RISKS, AND THAT THE OMRON PRODUCT(S) IS PROPERLY RATED AND INSTALLED FOR THE INTENDED USE WITHIN THE OVERALL EQUIPMENT OR SYSTEM.

Programmable Products.

Omron Companies shall not be responsible for the user's programming of a programmable Product, or any consequence thereof.

Performance Data.

Data presented in Omron Company websites, catalogs and other materials is provided as a guide for the user in determining suitability and does not constitute a warranty. It may represent the result of Omron's test conditions, and the user must correlate it to actual application requirements. Actual performance is subject to the Omron's Warranty and Limitations of Liability.

Change in Specifications.

Product specifications and accessories may be changed at any time based on improvements and other reasons. It is our practice to change part numbers when published ratings or features are changed, or when significant construction changes are made. However, some specifications of the Product may be changed without any notice. When in doubt, special part numbers may be assigned to fix or establish key specifications for your application. Please consult with your Omron's representative at any time to confirm actual specifications of purchased Product.

Errors and Omissions.

Information presented by Omron Companies has been checked and is believed to be accurate; however, no responsibility is assumed for clerical, typographical or proofreading errors or omissions.

2014.7

In the interest of product improvement, specifications are subject to change without notice.

OMRON Corporation
Industrial Automation Company

<http://www.ia.omron.com/>

(c)Copyright OMRON Corporation 2014 All Right Reserved.